



CARDIN ELETTRONICA spa
 Via Raffaello, 36- 31020 San Vendemiano (TV) Italy
 Tel: +39/0438.404011-401818
 Fax: +39/0438.401831
 email (Italy): Sales.office.it@cardin.it
 email (Europe): Sales.office@cardin.it
 Http: www.cardin.it

ZVL467.00 RCQ486W00

This product has been tried and tested in the manufacturer's laboratory, during the installation of the product follow the supplied indications carefully.



INTERFACCIA MULTIPROTOCOLLO MULTIPROTOCOL INTERFACE INTERFACE MULTIPROTOCOLE MULTIPROTOKOLL-SCHNITTSTELLE

ITALIANO

AVVERTENZE	Pagina	2
CARATTERISTICHE TECNICHE	Pagina	2
CREAZIONE DI UN ACCESSO CONTROLLATO	Pagina	3
INSTALLAZIONE DELL'INTERFACCIA	Pagina	4
COLLEGAMENTO TASTIERA DKS250T	Pagina	5-6
COLLEGAMENTO AL CONTROLLO ACCESSI	Pagina	6
SELEZIONE DEL PROTOCOLLO	Pagina	7
ABILITAZIONE CANALI	Pagina	8
ABILITAZIONE CON TIMER	Pagina	8
SEQUENZE DI BIT WIEGAND/ISO2/SERIALE	Pagine	9-13
TRONCAMENTO DEL CODICE	Pagina	14

FRANÇAIS

REMARQUE	Page	28
CARACTÉRISTIQUES TECHNIQUES	Page	28
CRÉATION D'UN ACCÈS CONTRÔLÉ	Page	29
MISE EN PLACE DE L'INTERFACE	Page	30
MISE EN PLACE DU CLAVIER DKS250T	Page	31-32
BRANCHEMENT AU CONTRÔLE D'ACCÈS	Page	32
SÉLECTION DU PROTOCOLE DE SORTIE	Page	33
VALIDATION DES CANAUX	Page	34
VALIDATION PAR TEMPORASITEUR	Page	34
SÉQUENCES DE BIT WIEGAND/ISO2/SÉRIEL	Page	35-39
ABBREVIATION DU CODE	Page	40

ENGLISH

IMPORTANT REMARKS	Page	15
TECHNICAL SPECIFICATIONS	Page	15
CREATING A ACCESS CONTROL SYSTEM	Page	16
INTERFACE INSTALLATION	Page	17
KEYBOARD INSTALLATION DKS250T	Page	18-19
CONNECTING TO AN ACCESS CONTROL DEVICE	Page	19
CHOOSING THE OUTPUT PROTOCOL	Page	20
ENABLING CHANNELS	Page	21
OPERATION USING A TIMER	Page	21
WIEGAND/ISO2/SERIAL BIT SEQUENCE	Page	22-26
CODE TRUNCATION	Page	27

DEUTSCH

ANWEISUNGEN	Seite	41
TECHNISCHE DATEN	Seite	41
ERSTELLUNG EINES EINFAHRTKONTROLLSYSTEMS	Seite	42
SCHNITTSTELLEN-INSTALLATION	Seite	43
TASTATUR-INSTALLATION DKS250T	Seite	44-45
ANSCHLUSS AN DAS EINFAHRTKONTROLLSYSTEM	Seite	45
WAHL DES AUSGANGSPROTOKOLLS	Seite	46
KANÄLFREIGABE	Seite	47
FREIGABE MIT ZEITSCHALTER	Seite	47
BIT-SEQUENZ WIEGAND/ISO2/SERIELL	Seite	48-52
CODE-ABBTRENNUNG	Seite	53

Prima di dar inizio all'installazione leggere attentamente il presente fascicolo. L'utilizzo dei prodotti e la loro destinazione ad usi diversi da quelli previsti e/o consigliati, non è stato sperimentato dal costruttore, pertanto i lavori eseguiti sono sotto la completa responsabilità dell'installatore.

Il presente manuale si rivolge a persone abilitate all'installazione di "APPARECCHI UTILIZZATORI DI ENERGIA ELETTRICA" e richiede una buona conoscenza della tecnica, esercitata in forma professionale. Il costruttore declina ogni responsabilità per eventuali danni provocati dalla mancata osservanza nell'installazione delle norme di sicurezza attualmente in vigore.

Descrizione

L'interfaccia **RCQ486W00** è un dispositivo in grado di decodificare il segnale proveniente o via radio da un trasmettitore Cardin mod. **S486** oppure via filo da una tastiera numerica Cardin mod. **DKS250T**, e di presentare ai morsetti d'uscita un segnale digitale in cui si trova il codice del trasmettitore attivato, in 13 formati differenti, selezionabili tramite Dip-switch a 4 vie. I segnali d'uscita seguono le normative **ISO-3554**, relative alla codifica in formato ABA Track (segnali **RCP, RDP, CLS**) oppure il protocollo **WIEGAND** (segnali DATA0 e DATA1 in 11 possibili configurazioni) o il protocollo **SERIALE**. È disponibile inoltre un contatto "**EN**" al quale può essere collegato un temporizzatore oppure un interruttore con lo scopo di abilitare o disabilitare l'interfaccia in diverse fasce orarie. L'uscita seriale **RS232** (indipendentemente dal protocollo selezionato) permette l'interfacciamento con un personal computer tramite un software di gestione utente, fornito con il kit.

Il kit comprende:

- l'interfaccia **RCQ486W00**
- un cavo seriale **RS232**
- un **CD Rom** con il software di controllo

CARATTERISTICHE TECNICHE

Alimentazione.....	12/24Vac/dc
Assorbimento.....	45 mA
Massima portata via radio: 100 - 150 m. in spazio libero	
Massima portata via filo con DKS250T : 150 m	
Uscite : 5V - 12V - TTL Open Collector	
Voh = 0.85 x Vdd: Vdd = 5V, Ioh = 1.2 mA max	
Vdd = 12V, Ioh = 2.9 mA max	
Vol = 0.4V, Iol = 15 mA max	

RICEVITORE

- frequenza di ricezione	868,3 MHz
- frequenza dell'oscillatore locale	857,6 MHz
- tolleranza dell'oscillatore locale	±30 PPM da -20 a +75 °C
- emissione dell'oscillatore locale	< -57 dBm
- sensibilità (per segnale a buon fine).....	-110 dBm 0,7 µV
- selettività.....	±30 kHz
- modulazione	FSK
- modulazione con ΔF.....	≤20 kHz
- impedenza di ingresso antenna.....	50 Ω
- temperatura di esercizio.....	-20° ...+75 °C

Dimensioni d'ingombro

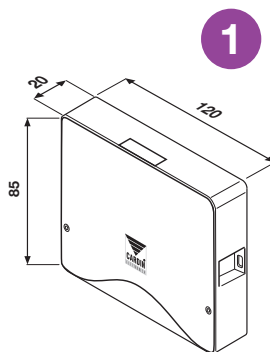

CREAZIONE DI UN ACCESSO CONTROLLATO

In base alla tipologia e alle caratteristiche d'impianto individuare il punto di posa del sistema. L'esempio di un accesso controllato sotto raffigurato può essere utile nella scelta dei componenti del sistema. Sebbene il modulo a radio frequenza (con caratteristiche tecniche descritte a pagina 2) sia fornito con il kit si ricorda che almeno un radiocomando **S486** oppure una tastiera numerica **DKS250T** devono essere acquistati a parte con i seguenti codici:

TRQ486100	Trasmettitori tascabili	1 funzione
TRQ486200	Trasmettitori tascabili	2 funzioni
TRQ486300	Trasmettitori tascabili	3 funzioni
TRQ486400	Trasmettitori tascabili	4 funzioni
TRQ48640M	Pulsantiera radio per fissaggio a muro	4 funzioni
DKS250T	Tastiera numerica da esterno	4 funzioni



Attenzione! Questo libretto riporta istruzioni per uso, installazione e manutenzione del solo ricevitore **RCQ486W00**. Per le istruzioni degli altri componenti del sistema si consulti il libretto fornito con il prodotto.

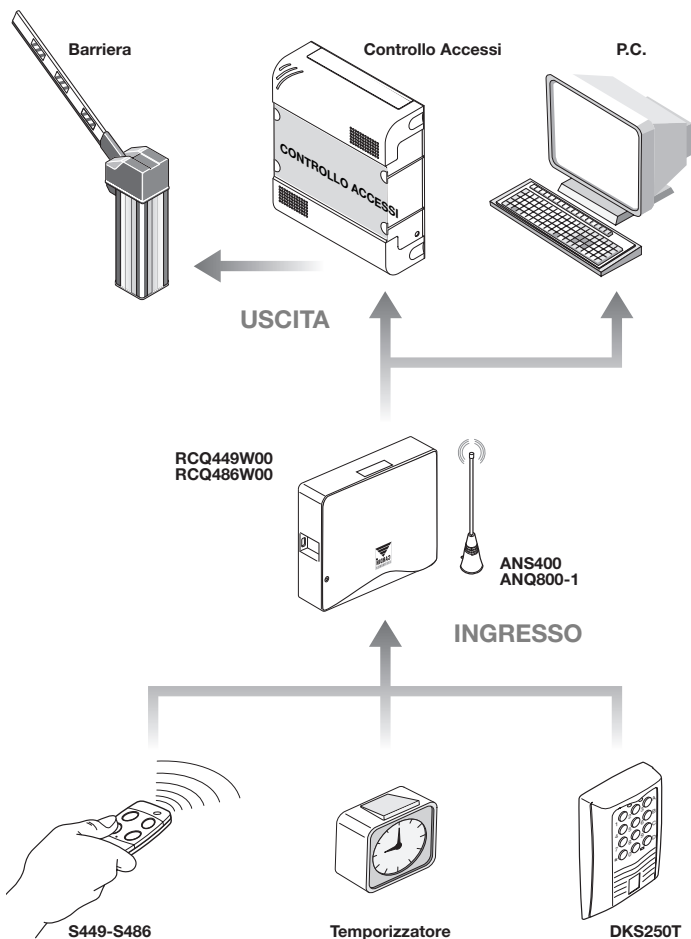

INSTALLAZIONE DELL'INTERFACCIA MULTIPROTOCOLLO RCQ486W00

L'interfaccia dovrà essere collocata:

- in ambiente interno (in contenitore stagno se installata all'esterno)
- al riparo da urti e manomissioni;
- in una posizione facilmente raggiungibile dal tecnico, per interventi di manutenzione.

Fissaggio:

- Svitare le due viti di fissaggio e alzare il coperchio
- Tracciare (con l'ausilio della scatola) i due punti di fissaggio e fissare il contenitore utilizzando due viti autofilettanti **M4** e relativi Fischer (non di nostra fornitura)
- Togliere le due protezioni in plastica sull'ingresso dei cavi.

Collegamento elettrico



Attenzione! Alimentare l'interfaccia esclusivamente con un alimentatore di sicurezza. L'utilizzo di alimentatori non di sicurezza può provocare pericolo.

L'interfaccia (circuit stampato CS1151B) è dotata di contenitore da interno e di morsettiera a 12 vie con collegamento elettrico:

12V ac/dc tra i morsetti 3-4

24V ac/dc tra i morsetti 3-5

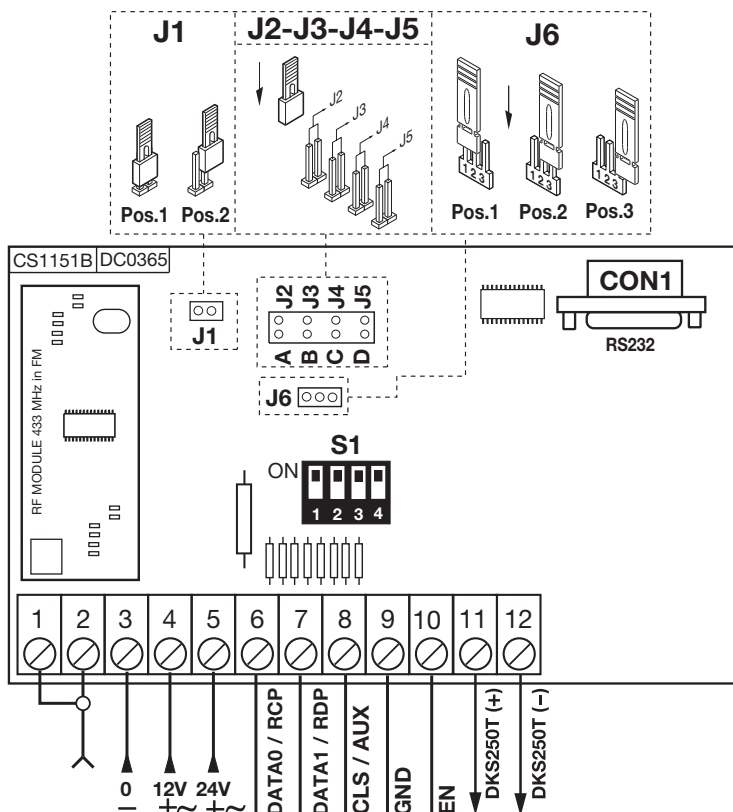

COLLEGAMENTO TASTIERA ESTERNA DKS250T

Qualora sia prevista l'installazione di una tastiera numerica procedere come segue:

- 1) Far passare i cavi di collegamento "1" provenienti dall'interfaccia attraverso il muro.

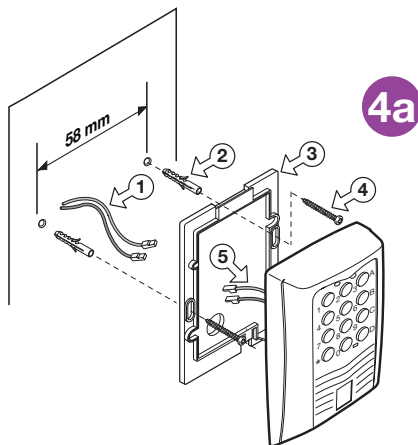

- 2) Forare il muro alla distanza indicata in figura 4a (58 mm).

- 3) Inserire i Fischer "2" forniti con il kit.

- 4) Bloccare la contropiastra "3" utilizzando le viti "4" fornite con il kit.

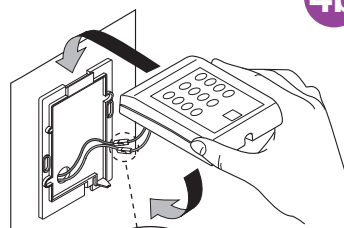



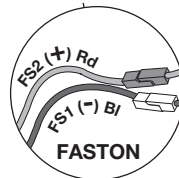

- 5) Collegare i faston dei cavi "1" ai faston della tastiera "5" (fig. 4a-4b):
- **filo rosso** dal tastierino al morsetto 12 del interfaccia
- **filo nero** dal tastierino al morsetto 11 del interfaccia

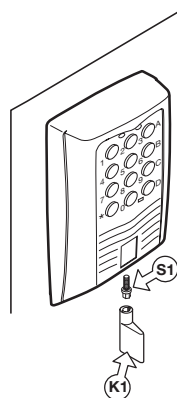

- 6) Infine posizionare la tastiera (fig 4b-4c) e bloccarla alla contropiastra utilizzando la vite speciale "S1" e l'apposito attrezzo "K1".

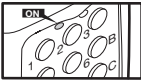

ATTIVAZIONE CODICE UTENTE DKS250T

-  Digitare sulla tastiera il codice numerico utente e premere conferma "*" 
 - La tastiera emette un **beep** per 2 secondi + LED verde acceso  
 -  Premere A-B-C o D nella colonna a destra sulla tastiera (Es. "C")  **C**
- Attivazione avvenuta!**
- Dopo 5 secondi di inattività verrà emesso un **beep**. Il LED verde si spegne e si esce dalla modalità.

COLLEGAMENTO ANTENNA ESTERNA ANQ800-1

Qualora sia previsto l'uso di radiocomandi, l'installazione dell'antenna diventa fondamentale; infatti collegata al ricevitore rappresenta il punto di ricezione del radiocomando. È necessario collegare al ricevitore l'antenna **ANQ800-1** accordata mediante cavetto coassiale **RG58** (impedenza **50Ω**) di lunghezza max. **15m**; l'antenna va posizionata all'esterno nel punto più elevato e visibile, lontano da strutture metalliche.

- Collegare la massa dell'antenna al morsetto "1" ed il polo al morsetto "2".

COLLEGAMENTO AL DISPOSITIVO DI CONTROLLO ACCESSI



Attenzione: La scelta deve essere effettuata tra le possibilità "**WIEGAND, ISO2 o SERIALE**". Non è possibile utilizzare più protocolli contemporaneamente.

Protocollo WIEGAND o SERIALE

Il collegamento fisico tra il controllo accessi e l'interfaccia **RCQ486W00** si effettua tra i morsetti: **6 (DATA 0)**, **7 (DATA 1)** e **9 (GND)**

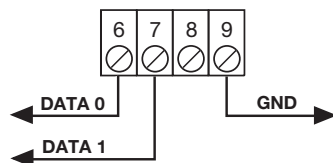

Protocollo ISO2 (magnetic stripe)

Il collegamento fisico tra il controllo accessi e l'interfaccia **RCQ486W00** si effettua tra i morsetti **6 (RCP, "read clock pulse")**, **7 (RDP, "read data pulse")**, **8 (CLS, "card loading signal")** e **9 (GND)**

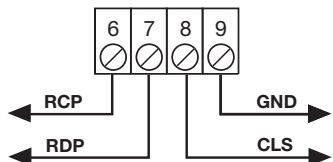

SELEZIONE DEL PROTOCOLLO DI USCITA

L'interfaccia dispone di 13 formati differenti per comunicare con una centrale di controllo accessi. Sono disponibili 11 formati **WIEGAND**, un formato **ISO 2**, ed un formato **SERIALE** selezionabili tramite il Dip-Switch "S1".



DIP1	DIP2	DIP3	DIP4	PROTOCOL
ON	OFF	OFF	OFF	WIEGAND 26 BIT
ON	OFF	ON	OFF	WIEGAND 26 BIT SITE
ON	OFF	ON	ON	WIEGAND 26 BIT SITE + CH
OFF	ON	OFF	OFF	WIEGAND 37 BIT
OFF	ON	OFF	ON	WIEGAND 37 BIT + CH
OFF	ON	ON	OFF	WIEGAND 37 BIT SITE
OFF	ON	ON	ON	WIEGAND 37 BIT SITE + CH
OFF	OFF	ON	OFF	WIEGAND 37 BIT D10302
OFF	OFF	ON	ON	WIEGAND 37 BIT D10302 (BCD)
ON	ON	OFF	OFF	WIEGAND 50 BIT
ON	ON	OFF	ON	WIEGAND 50 BIT + CH
OFF	OFF	OFF	ON	ISO 2
ON	ON	ON	ON	SERIAL

Per una spiegazione dettagliata della sequenza di bit inviata nei vari formati consultare pagine 9-13.

SELEZIONE DELLA TENSIONE DI USCITA

Sono disponibili tre modalità per la tensione dei segnali in uscita nei formati **WIEGAND**, **ISO2** e **SERIALE**:

1) **12Vdc** in uscita con jumper "J6" in posizione "1"

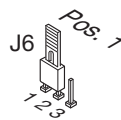

2) **5Vdc** in uscita con jumper "J6" in posizione "2"

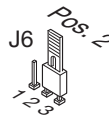

3) **TTL Open collector** in uscita con jumper "J6" in posizione "3"
(contatto aperto)



ABILITAZIONE DI CANALI RADIOCOMANDO/TASTIERA

Per abilitare/disabilitare l'attivazione dell'uscita in formato **WIEGAND**, **ISO2** o **SERIALE** inserire i jumper "J2", "J3", "J4", "J5" come segue:

- 1) Con il jumper "J2" inserito, il canale "A" del trasmettitore **S486** o della tastiera **DKS250T** attiva la funzione "A" del ricevitore **RCQ486W00**. Tutti gli altri canali sono disabilitati.

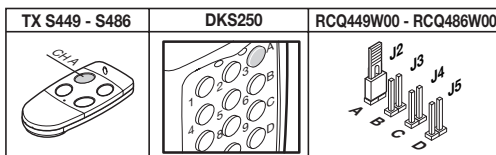

- 2) Con il jumper "J3" inserito, il canale "B" del trasmettitore **S486** o della tastiera **DKS250T** attiva la funzione "B" del ricevitore **RCQ486W00**. Tutti gli altri canali sono disabilitati.

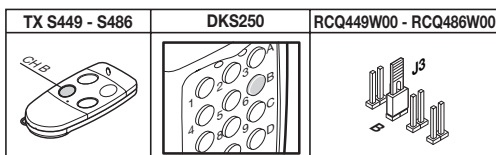

- 3) Con il jumper "J4" inserito, il canale "C" del trasmettitore **S486** o della tastiera **DKS250T** attiva la funzione "C" del ricevitore **RCQ486W00**. Tutti gli altri canali sono disabilitati.

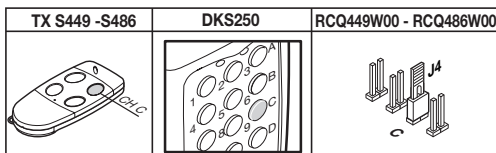

- 4) Con il jumper "J5" inserito, il canale "D" del trasmettitore **S486** o della tastiera **DKS250T** attiva la funzione "D" del ricevitore **RCQ486W00**. Tutti gli altri canali sono disabilitati.

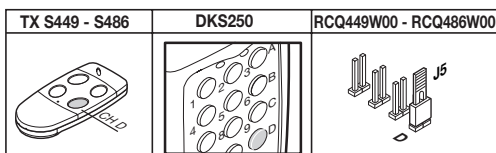

- 5) Con i jumper "J2" e "J5" inseriti, i canali "A" e "D" del trasmettitore **S486** o della tastiera **DKS250T** attiveranno rispettivamente le funzioni "A" e "D" del ricevitore **RCQ486W00**. Tutti gli altri canali sono disabilitati.

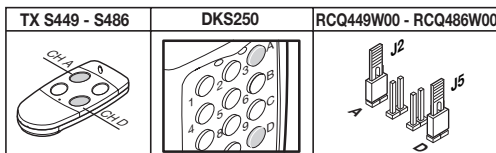

Sono possibili tutte le combinazioni fino ad un massimo di 4 tasti di canale.

ABILITAZIONE CON TEMPORIZZATORE

Collegando un timer oppure un interruttore semplice tra i morsetti 9 e 10 si ha la possibilità di abilitare o disabilitare l'interfaccia in diverse fasce orarie. Esempio: se nessuno deve entrare nella zona o stabilimento controllato dopo le dieci di sera basta impostare il temporizzatore in maniera che apra il contatto "EN" dopo tale ora.

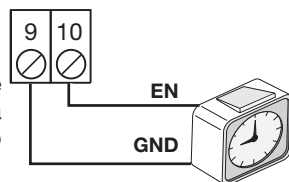

Attenzione: Se non si collega nessun dispositivo tra i morsetti 9 e 10 il contatto **deve essere** ponticellato. L'interfaccia non attiva l'uscita **WIEGAND/ISO2/SERIALE** con questo contatto aperto.

SOFTWARE DI INTERFACCIA SU PC

Collegando un personal computer al ricevitore **RCQ486W00** tramite l'interfaccia **RS232** ed installando il software di gestione fornito su **CD Rom** (il cavo ed il **CD Rom** sono forniti con il kit) si può ottenere un elenco degli eventi (ossia le entrate ed uscite giornaliere del sistema). Per una spiegazione dettagliata del software si consulti il manuale d'istruzione registrato in formato PDF sul **CD Rom** stesso.

PROTOCOLLO WIEGAND (SEQUENZE DI BIT)

Nota 1: Nella sequenza dei bit inviati in uscita, il primo ad essere trasmesso è il bit 1

1) WIEGAND 26 bit

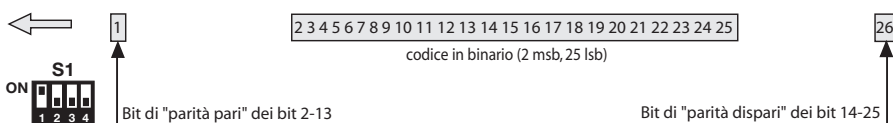

Attenzione! Il codice è limitato a **16'777'215**. Per utilizzare codici con numero più grande, consultare a pagina 14 il paragrafo **"Troncamento del codice"**

2) WIEGAND 26 bit con codice SITO

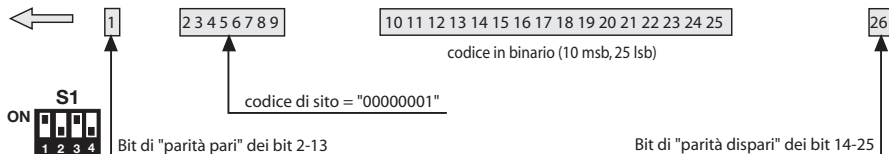

Attenzione! Il codice è limitato a **65'535**. Per utilizzare codici con numero più grande, consultare a pagina 14 il paragrafo **"Troncamento del codice"**

3) WIEGAND 26 bit con codice SITO + informazione di canale

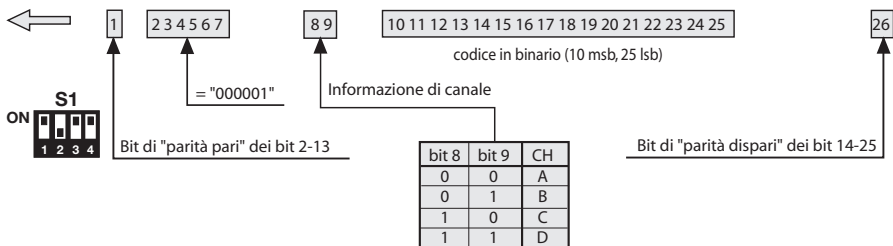

Attenzione! Il codice è limitato a **65'535**. Per utilizzare codici con numero più grande, consultare a pagina 14 il paragrafo **"Troncamento del codice"**

4) WIEGAND 37 bit

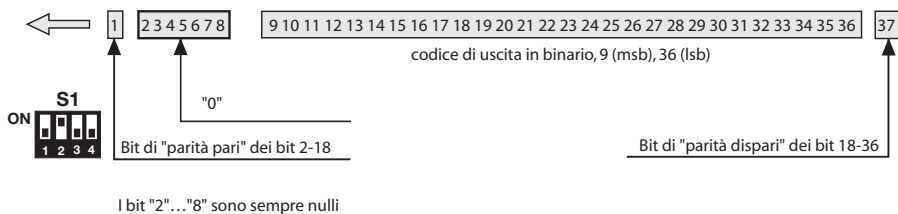

5) WIEGAND 37 bit + informazione di canale

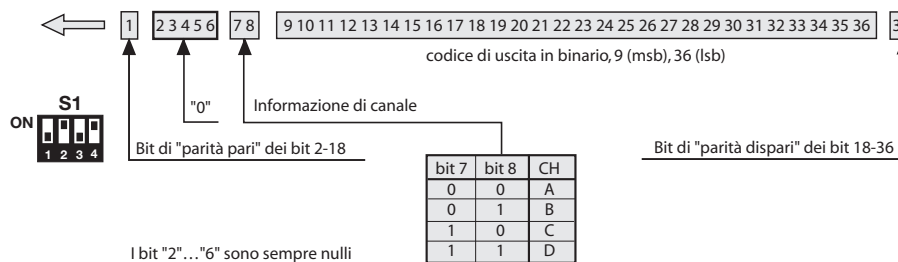

6) WIEGAND 37 bit con codice SITO

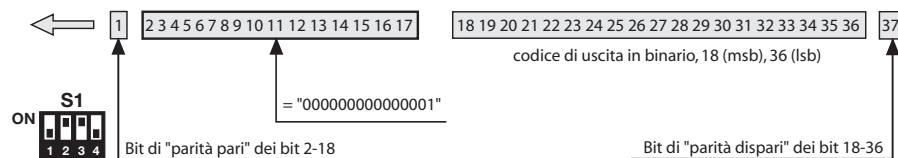

Attenzione! Il codice è limitato a **524'287**. Per utilizzare codici con numero più grande, consultare a pagina 14 il paragrafo **"Troncamento del codice"**

7) WIEGAND 37 bit con codice SITO + informazione di canale

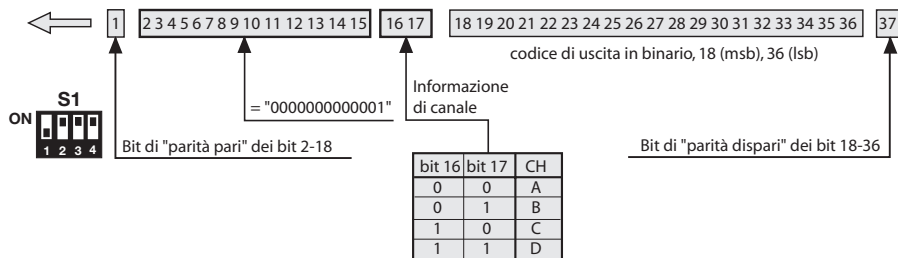

Attenzione! Il codice è limitato a **524'287**. Per utilizzare codici con numero più grande, consultare a pagina 14 il paragrafo **"Troncamento del codice"**

8) WIEGAND 37 bit D10302

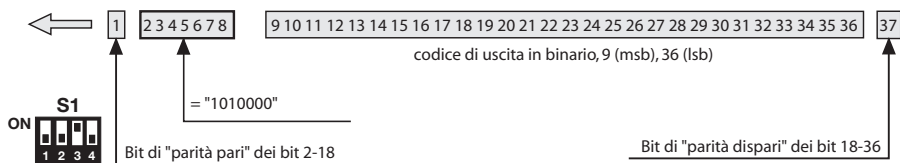

9) WIEGAND 37 bit D10302 (BCD)

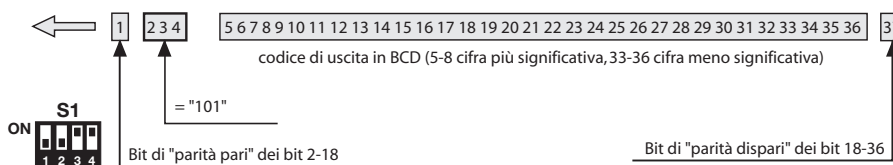

Attenzione! Il codice è limitato a **99'999'999**. Per utilizzare codici con numero più grande, consultare a pagina 14 il paragrafo **"Troncamento del codice"**

10) WIEGAND 50 bit

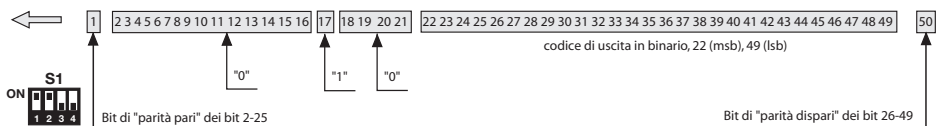

11) WIEGAND 50 bit + informazione di canale

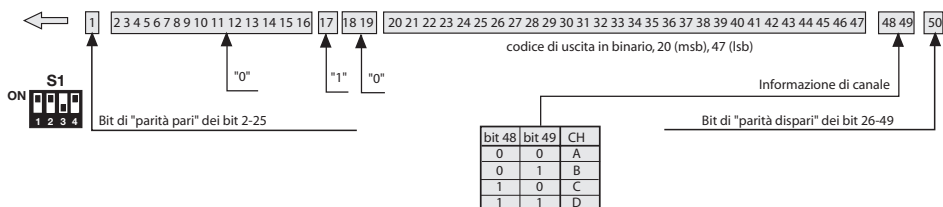

Diagrammi temporali dei segnali WIEGAND

La trama in formato **WIEGAND** viene emessa attraverso i segnali **DATA0** e **DATA1**. La durata del singolo bit è di $50\mu\text{s}$ mentre l'attesa tra un bit ed il successivo è di 2ms .

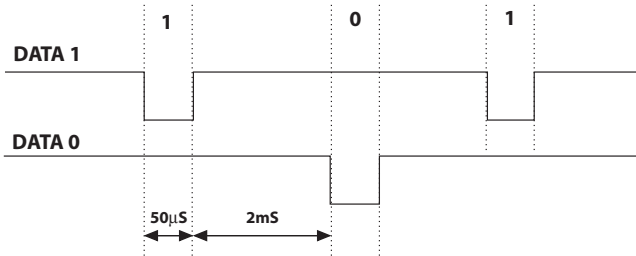

PROTOCOLLO ISO2 (SEQUENZE DI BIT)

Parità	B4	B3	B2	B1	Carattere
1	0	0	0	0	0
0	0	0	0	1	1
0	0	0	1	0	2
1	0	0	1	1	3
0	0	1	0	0	4
1	0	1	0	1	5
1	0	1	1	0	6
0	0	1	1	1	7
0	1	0	0	0	8
1	1	0	0	1	9
0	1	0	1	1	START
0	1	1	0	1	SEP
0	1	1	1	1	END

La trama che esce dall'interfaccia è formata da 16 caratteri. Ogni carattere è costituito da 5 bit secondo la codifica della tabella, dove il bit più significativo è **B4**, il meno significativo è **B1**.

Il bit di parità è la parità dispari di **B4**, **B3**, **B2**, **B1**.

La trama è la seguente: START + CANALE (1 carattere) + SEP + CODICE (10 caratteri) + SEP + END + LRC, cioè 16 caratteri in totale.

Esempio di costruzione trama limitata a 6 caratteri: trasmissione del codice "452"

SIGNIFICATO	BIT	PARITÀ
Start	1 0 1 1	0
"4"	0 1 0 0	0
"5"	0 1 0 1	1
"2"	0 0 1 1	0
End	1 1 1 1	1
LRC	0 1 1 1	0

Alla fine della trama viene inviato il carattere di controllo **LRC**, che viene calcolato facendo la parità pari in senso longitudinale (sulle colonne) dei corrispondenti bit come si vede nella tabella.

Il primo bit ad uscire è **B1** e l'ultimo è quello di parità.

Diagrammi temporali dei segnali ISO2

I segnali **ISO2** sono 3: **CLS** (Card Loading Signal), **RCP** (Read Clock Pulse) e **RDP** (Read Data Pulse). I 3 segnali sono attivi bassi.

Prima di tutto si abbassa **CLS** e dopo 5ms si inviano 10 "colpi" di clock; poi si invia il pacchetto di dati e alla fine si attendono 5ms prima di alzare **CLS**.

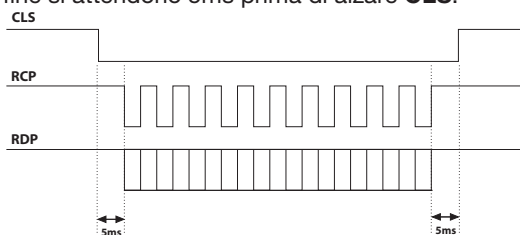

Il periodo (T_p) ha una durata di 1ms ed è così costituito:

400 μ s in cui le linee **RDP** (dati) e **RCP** (clock) sono alte

300 μ s in cui la linea **RDP** è bassa se il bit vale 1 (**RCP** è sempre alto)

300 μ s (T_{ck}) in cui la linea **RCP** è bassa (**RDP** mantiene il livello che aveva prima)

Alla fine del periodo, **RCP** e **RDP** tornano al livello alto.

$$T_{ck} = 300\mu s$$

$$T_d = 600\mu s$$

$$T_p = 1ms$$

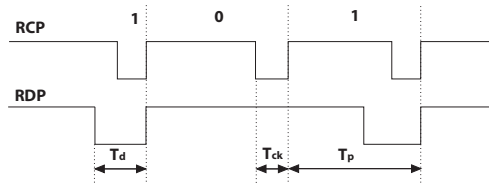

PROTOCOLLO SERIALE (SEQUENZE DI BIT)

Il protocollo seriale presenta all'uscita del morsetto **DATA0** il protocollo standard **RS232** (baudrate = 9600, senza parità, 8 bit, e un bit di stop) nel seguente formato:

00C000B₁B₂B₃B₄B₅0

dove 0 è il carattere ASCII "0" (30h), **B₁B₂B₃B₄B₅** sono le 5 cifre meno significative del codice in esadecimale e "**C**" rappresenta il canale trasmesso secondo la tabella:

CANALE	CAR
A	1 (31h)
B	2 (32h)
C	4 (34h)
D	8 (38h)

L'uscita **DATA1** viene attivata 200ms prima di inviare i dati sull'uscita **DATA0** nel seguente modo:

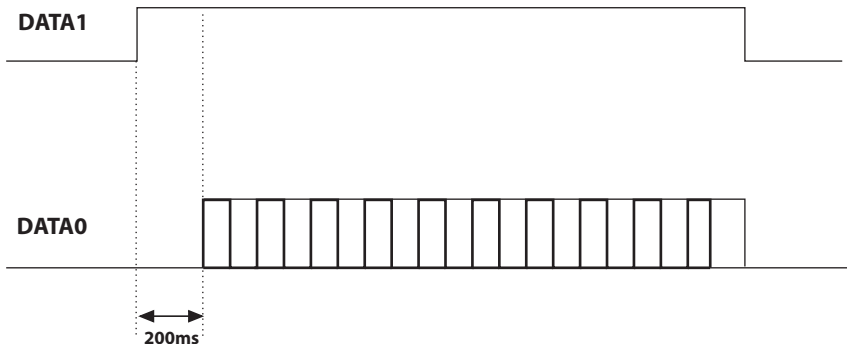

TRONCAMENTO DEL CODICE

Scegliendo il protocollo **WIEGAND** 1,2,3,6,7 e 9 (pagine 9-11) è possibile che il codice del trasmettitore **S486** sia superiore al massimo codice rappresentabile con i bit a disposizione. Con jumper "**J1**" disinserito, nessuna uscita **WIEGAND** sarà attivata, mentre sarà disponibile sull'uscita **RS232** l'informazione sul codice ricevuto.

Inserendo il jumper "**J1**" si attiva la funzione "**troncamento codice**", che provvederà ad eliminare i bit più significativi non rappresentabili nel formato **WIEGAND** selezionato.

Es 1:

Se si seleziona il protocollo **WIEGAND** 26 bit con codice SITO (limite **65'535**) ed il codice del trasmettitore è **356'890**, la funzione di troncamento cancellerà la prima cifra e il codice che verrà inviato in uscita **WIEGAND** sarà dunque **56'980** (numero minore di **65'535**).

Es 2:

Se si seleziona il protocollo **WIEGAND** 37 bit con codice SITO (limite **542'287**) ed il codice del trasmettitore è **18'436'500**, la funzione di troncamento restituirà il codice **436'500**.



Attenzione! Attivando la funzione di "Troncamento codice" (jumper "**J1**" chiuso) è possibile che due trasmettitori, pur con codice diverso, attivino all'uscita dell'interfaccia una sequenza di bit identica.

Ad esempio, nel caso del formato **WIEGAND** 26 bit con codice SITO i codici **138'612** e **238'612** attivano in uscita la stessa sequenza di bit: **38'612**.

Before commencing with the installation of this appliance make sure that you have read the following instructions carefully. The use and installation of these appliances must rigorously respect the indications supplied by the manufacturer. The manufacturer accepts no liability for damage caused by, or situations arising from, the improper use of these appliances. These instructions are aimed at professionally qualified "installers of electrical equipment" and must respect the local standards and regulations in force.

Description

The **RCQ486W00** interface is a device which is able to decode a radio frequency signal coming from a Cardin **S486** transmitter or via cable coming from the Cardin numerical keyboard **DKS250T**. Once decoded this signal is converted into a digital frame containing the transmitter code it is sent to the output in 13 different formats which can be selected by means of a four-way Dip-switch. The output signals follow the **ISO-3554** standard encoded in ABA track (**RCP**, **RDP**, **CLS** signals), the **WIEGAND** protocol (**Data0** and **Data1** signals in 11 possible configurations) or the **SERIAL** protocol. The interface also has an enable contact "**EN**" which can be wired to a timer or a normal switch allowing you to activate or deactivate the interface in different time bands. The **RS232** serial interface (despite which protocol you have selected) allows you to connect the device to a personal computer using software supplied with the kit.

The kit contains the following:

- the interface **RCQ486W00**
- a serial cable **RS232**
- a **CD Rom** containing the management software

TECHNICAL SPECIFICATIONS

Power supply	12/24Vac-dc
Power consumption	45 mA
Maximum range via radio: 100 - 150 m. in open space	
Maximum range via cable using the DKS250T : 150 m	
Outputs : 5V - 12V - TTL Open Collector	
Voh = 0.85 x Vdd: Vdd = 5V, Ioh = 1.2 mA max.	
Vdd = 12V, Ioh = 2.9 mA max.	
Vol = 0.4V, Iol = 15 mA max	

RECEIVER

- reception frequency	868,3 MHz
- local oscillation frequency	857,6 MHz
- local oscillation tolerance	± 30 PPM from -20 to +75 °C
- local oscillation emission	<-57 dBm
- sensitivity (for a fine signal)	-110 dBm 0,7 µV
- selectivity	±30 kHz
- modulation	FSK
- modulation with ΔF	≤20 kHz
- Antenna impedance	50 Ω
- Operating temperature	-20° ... +75 °C

Overall dimensions

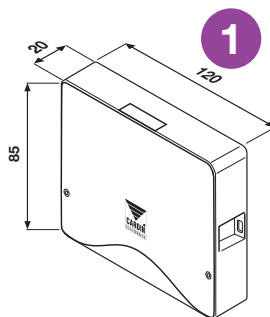

CREATING AN ACCESS CONTROL SYSTEM

According to the type and characteristics of the system work out where it will be installed. The access control system example shown below could be useful when choosing the individual components that will make up the system. Although the receiver module (technical specifications on page 15) is included in the **DKS250T** kit you must separately acquire at least one **S486** transmitter or a numerical code keyboard from the following list:

TRQ486100	Pocket transmitters	1 function
TRQ486200	Pocket transmitters	2 functions
TRQ486300	Pocket transmitters	3 functions
TRQ486400	Pocket transmitters	4 functions
TRQ48640M	Wall mounted transmitter	4 functions
DKS250T	Numerical all-weather keyboard	4 functions



Attention! This manual contains user, installation and maintenance instructions for the **RCQ486W00** interface. For instructions regarding other components making up the system consult the manuals supplied with the products.

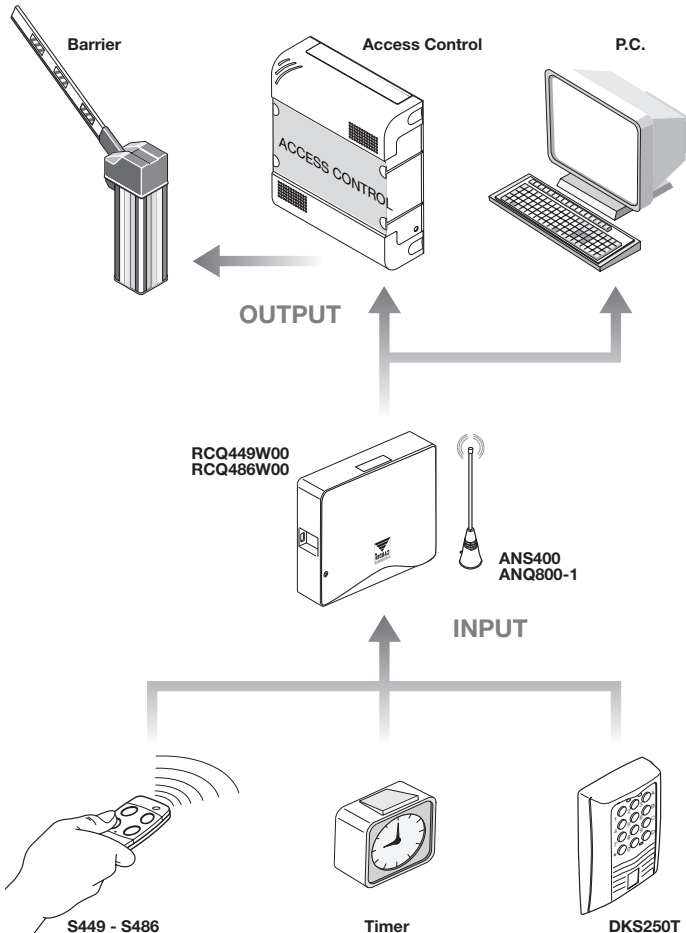

INSTALLING THE RCQ486W00 MULTIPROTOCOL INTERFACE

The interface site must be:

- indoors (or stored in a waterproof container if installed outdoors)
- a position safe from accidental collision;
- in a position which the technician can easily reach.

Fastening:

- Remove the two holding screws and lift up the cover
- Using the container as a template mark the four points at which the fastening holes are to be drilled and fasten down using four self-tapping **M4** screws and relative rawlplugs (not supplied with the kit).
- Remove the two plastic cable dividers.

Electrical connection



Warning! The receivers must only be powered by a safety power pack. The use of non safety power packs could provoke damage to the system.

The interface (printed circuit CS1151B) is fitted with an indoor container and has a 12-way terminal board with the following electrical connection:

12V ac/dc between binding posts **3-4**

24V ac/dc between binding posts **3-5**

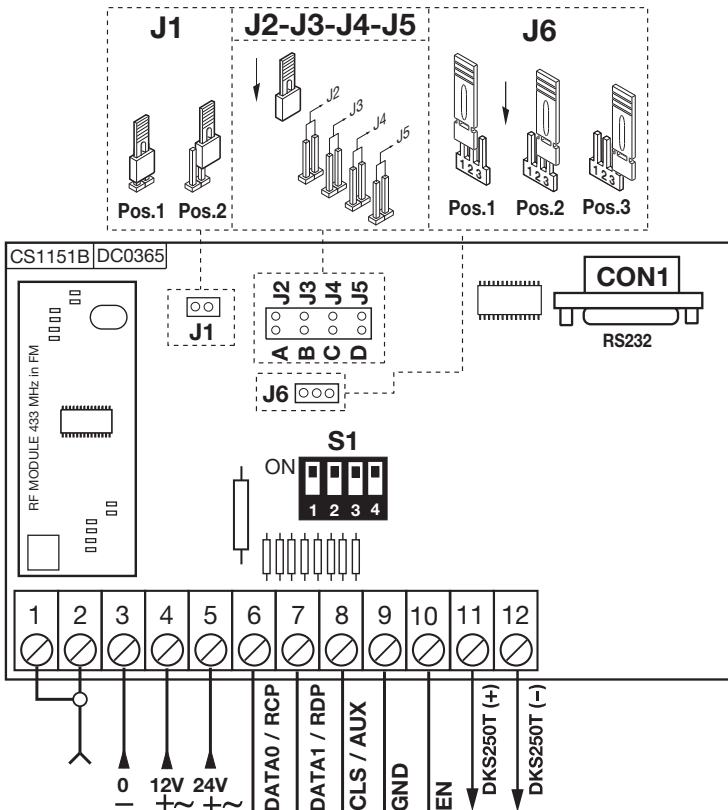

CONNECTING THE ALL-WEATHER NUMERICAL KEYBOARD DKS250T

If you have decided to install a keyboard proceed as follows:

- 1) Pass the connecting cables, "1" coming from the interface, through the wall.

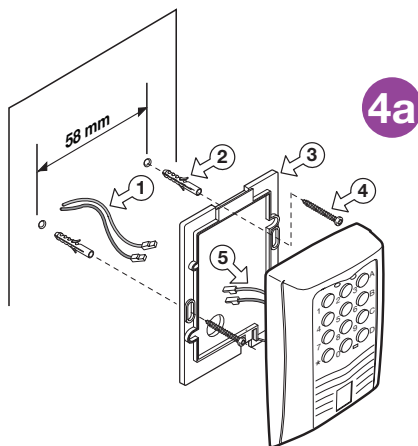

- 2) Drill the wall at the distance indicated in figure 4a (58 mm).

- 3) Insert the rawplugs "2" supplied with the kit.

- 4) Fasten down the counter plate "3" using the screws "4" supplied with the kit.

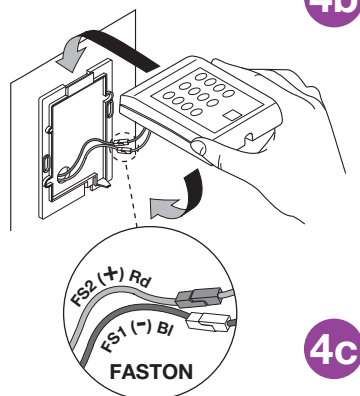



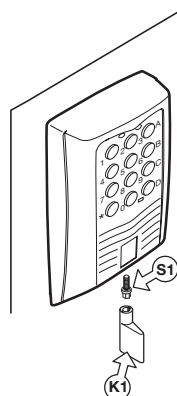

- 5) Connect the Fastons on the wires "1" to the Fastons on the keyboard "5" (fig. 4a-4b):
 - the **red wire** of the keyboard connects to binding post 12 on the interface card
 - the **black wire** of the keyboard connects to binding post 11 on the interface card

- 6) Position the keyboard (fig 4b-4c) and fasten it down to the counter plate using the special screw "S1" and the tool "K1".

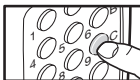

ACTIVATING A USER CODE DKS250T

- 1  Type in the numerical user code on the keyboard and press confirm "*" 
 - 2 The keyboard will emit a **beep** for 2 seconds and the green LED will light up.  
 - 3  Press A-B-C or D in the right-hand column of the keyboard (e.g. "C")  **C**
- Activation has been carried out!**
- 4 After 5 seconds of inactivity a **beep** will sound. The green LED will switch off and you will quit the user code mode.

CONNECTING THE EXTERNAL ANTENNA ANQ800-1

If you have decided to use transmitters the installation of the antenna is fundamental: In fact connected to the receiver it represents the reception point for the transmitter. An **ANQ800-1** tuned antenna using a coaxial cable **RG58** (impedance **50Ω**) with a maximum length of **15m** must be installed. The antenna should be positioned out of doors in the highest possible point, visible and away from metal structures.

- Connect the antenna mass to binding post "1" and the antenna pole to binding post "2"

CONNECTING TO AN ACCESS CONTROL DEVICE



Attention: You must choose between "WIEGAND, ISO2 and SERIAL".
Two different protocols cannot be used contemporaneously

WIEGAND or SERIAL protocol

The physical connection between the access control device and the **RCQ486W00** interface is carried out at the following binding posts:

6 (DATA 0), **7** (DATA 1) and **9** (**GND**)

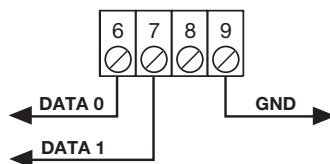

ISO2 protocol (magnetic stripe)

The physical connection between the access control device and the **RCQ486W00** interface is carried out at the following binding posts: **6** (RCP, "read clock pulse"), **7** (RDP, "read data pulse"), **8** (CLS, "card loading signal") and **9** (**GND**)

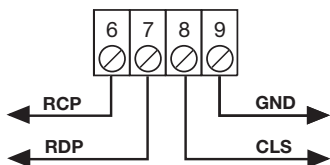

CHOOSING THE OUTPUT PROTOCOL

The interface has thirteen different formats for communicating with the access control device. 11 of these formats are **WIEGAND**, one is **ISO2** and the other is **SERIAL** and they can be selected using the dip-switch "S1".



DIP1	DIP2	DIP3	DIP4	PROTOCOL
ON	OFF	OFF	OFF	WIEGAND 26 BIT
ON	OFF	ON	OFF	WIEGAND 26 BIT SITE
ON	OFF	ON	ON	WIEGAND 26 BIT SITE + CH
OFF	ON	OFF	OFF	WIEGAND 37 BIT
OFF	ON	OFF	ON	WIEGAND 37 BIT + CH
OFF	ON	ON	OFF	WIEGAND 37 BIT SITE
OFF	ON	ON	ON	WIEGAND 37 BIT SITE + CH
OFF	OFF	ON	OFF	WIEGAND 37 BIT D10302
OFF	OFF	ON	ON	WIEGAND 37 BIT D10302 (BCD)
ON	ON	OFF	OFF	WIEGAND 50 BIT
ON	ON	OFF	ON	WIEGAND 50 BIT + CH
OFF	OFF	OFF	ON	ISO 2
ON	ON	ON	ON	SERIAL

For a detailed description of the bit transmission sequence consult pages 21 to 23.

SELECTING THE OUTPUT VOLTAGE

There are three different methods for choosing the output voltage for the formats **WIEGAND**, **ISO2** and **SERIAL**.

1) **12Vdc** output with jumper "J6" in position "1"

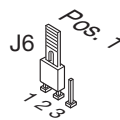

2) **5Vdc** output with jumper "J6" in position "2"

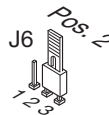

3) **TTL** Open collector output with jumper "J6" in position "3"
(open contact)



ENABLING CHANNELS FOR THE TRANSMITTER/KEYBOARD

To activate/deactivate the **WIEGAND** or **ISO2** format outputs insert the jumpers "J2", "J3", "J4", "J5" as follows:

- 1) With jumper "J2" inserted, channel "A" of the transmitter **S486** or the keyboard **DKS250T** activates function "A" on the interface **RCQ486W00**.
All the other channels are deactivated.

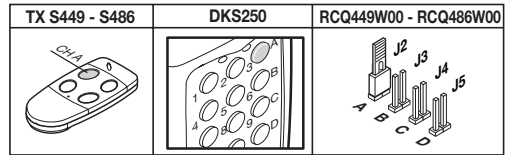

- 2) With jumper "J3" inserted, channel "B" of the transmitter **S486** or the keyboard **DKS250T** activates function "B" on the interface **RCQ486W00**.
All the other channels are deactivated.

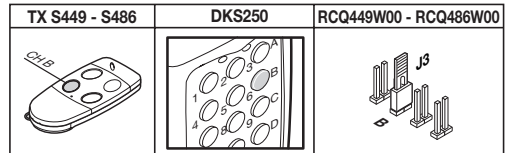

- 3) With jumper "J4" inserted, channel "C" of the transmitter **S486** or the keyboard **DKS250T** activates function "C" on the interface **RCQ486W00**.
All the other channels are deactivated.

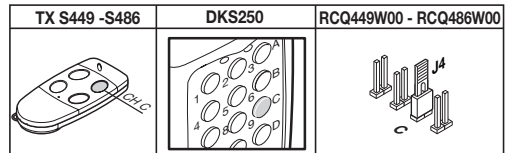

- 1) With jumper "J5" inserted, channel "D" of the transmitter **S486** or the keyboard **DKS250T** activates function "D" on the interface **RCQ486W00**.
All the other channels are deactivated.

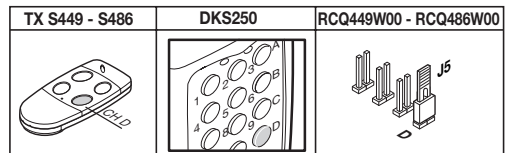

- 5) With jumpers "J2" and "J5" inserted, the channels "A" and "D" of the transmitter **S486** or the keyboard **DKS250T** will activate the functions "A" and "D" respectively on the interface **RCQ486W00**.
All the other channels are deactivated.

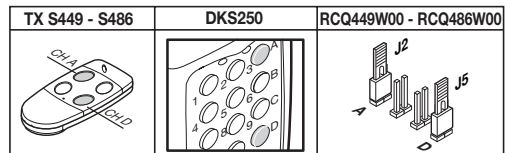

All other possible combinations are allowed up to a maximum of four channel buttons

OPERATION USING A TIMER

By connecting a timer or a simple switch between binding posts 9 and 10 you can activate or deactivate the interface in different time bands. Eg: if nobody is to be allowed to enter the controlled zone or plant after 10 o'clock in the evening you need only set the timer to deactivate the "EN" contact after that hour.

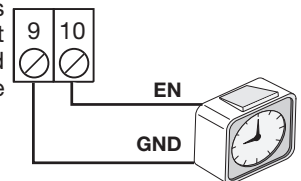

Attention: If you don't connect a device between binding posts 9 and 10 the contact **must be** bridged. The **WIEGAND/ISO2/SERIAL** transmission cannot function with this contact open.

PC INTERFACE SOFTWARE

Connecting a personal computer to the **RCQ486W00** interface using **RS232** and then installing the management software included in the **CD Rom** (the cable and **CD Rom** are supplied with the kit) you can obtain a list of events (i.e. daily entry and exits from the system). For a detailed description of the software consult the PDF instruction manual which can be found on the **CD Rom** itself.

WIEGAND PROTOCOL (BIT FLOW SEQUENCE)

Note 1: The first bit to be transmitted in the output sequence is bit 1

1) WIEGAND 26 bit

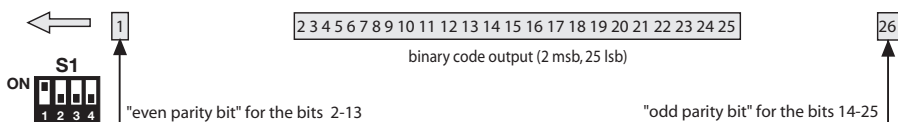

Attention! The code is limited to **16'777'215**. To use codes with greater numbers, consult the paragraph "**Code truncation**" on page 27

2) WIEGAND 26 bit with site code

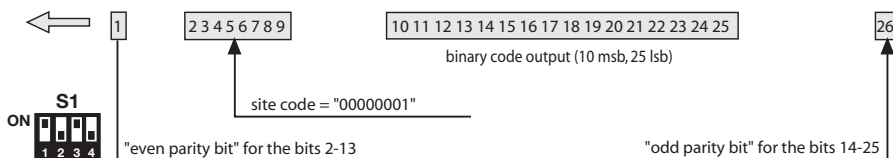

Attention! The code is limited to **65'535**. To use codes with greater numbers, consult the paragraph "**Code truncation**" on page 27

3) WIEGAND 26 bit with site code and channel information

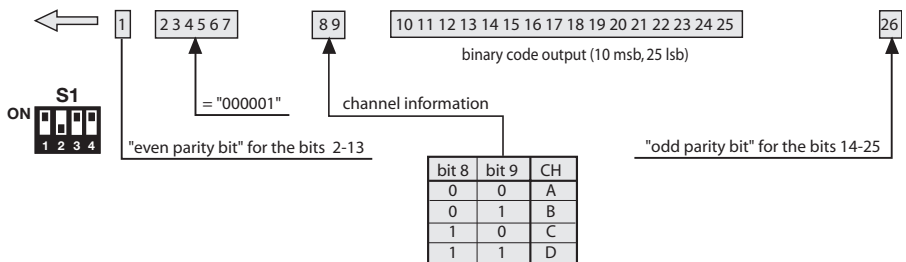

Attention! The code is limited to **65'535**. To use codes with greater numbers, consult the paragraph "**Code truncation**" on page 27

4) WIEGAND 37 bit

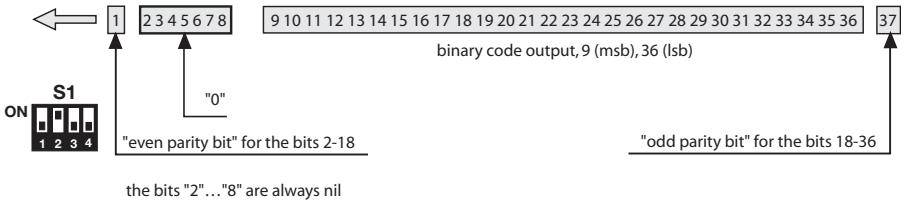

5) WIEGAND 37 bit and channel information

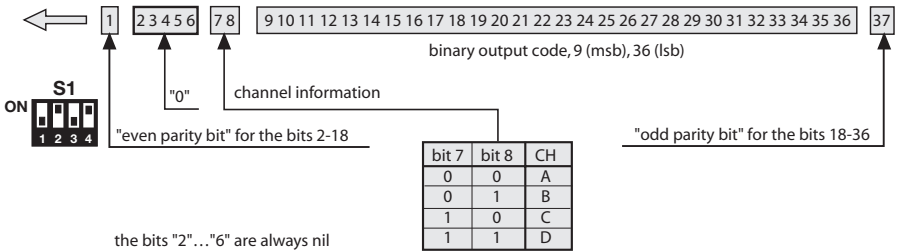

6) WIEGAND 37 bit with site code

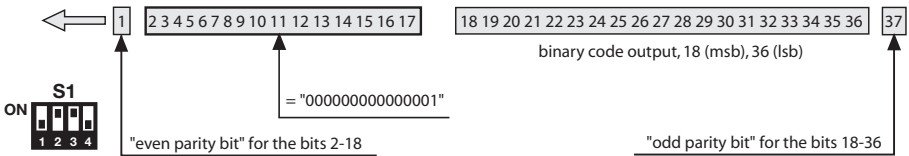

Attention! The code is limited to **524'287**. To use codes with greater numbers, consult the paragraph **"Code truncation"** on page 27

7) WIEGAND 37 bit with site code and channel information

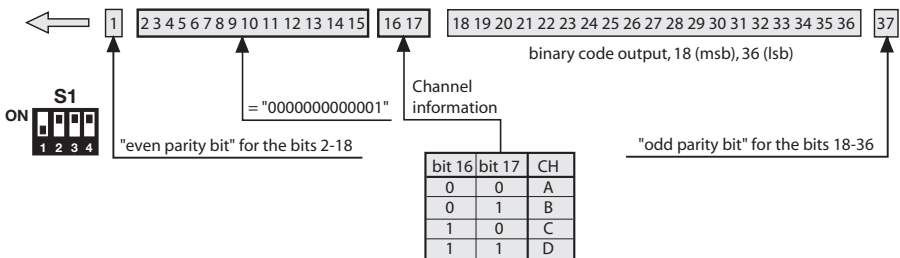

Attention! The code is limited to **524'287**. To use codes with greater numbers, consult the paragraph **"Code truncation"** on page 27

8) WIEGAND 37 bit D10302

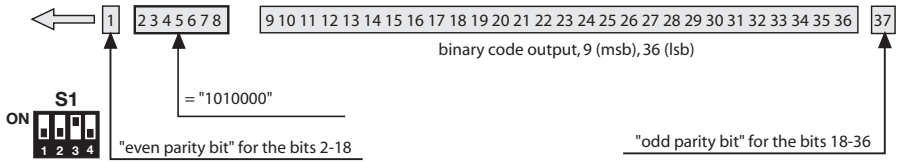

9) WIEGAND 37 bit D10302 (BCD)

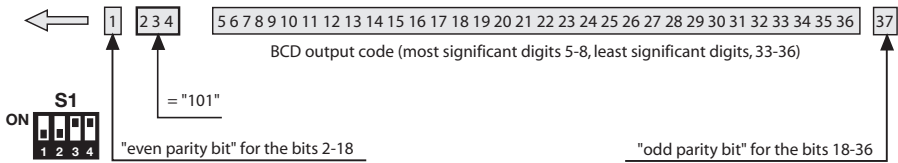

Attention! The code is limited to **99'999'999**. To use codes with greater numbers, consult the paragraph "**Code truncation**" on page 27

10) WIEGAND 50 bit

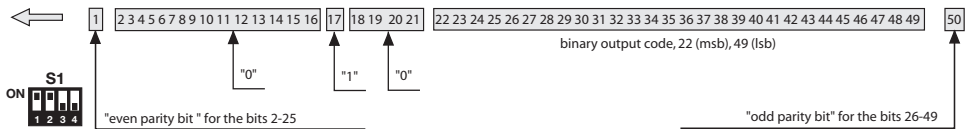

11) WIEGAND 50 bit with channel information

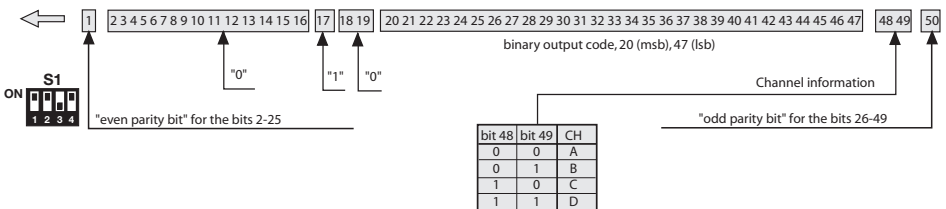

Frame make up for the WIEGAND signals

The frame in the **WIEGAND** format is emitted by means of the **DATA0** and **DATA1** signals. The duration of each single bit is $50\mu\text{s}$ while the waiting period between one bit and the next is 2ms.

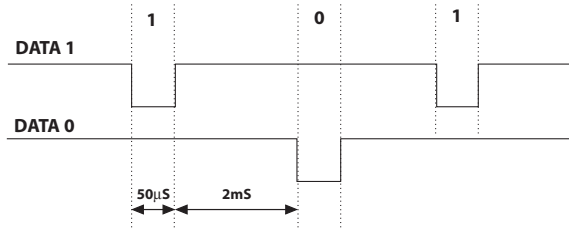

ISO2 PROTOCOL (BIT FLOW SEQUENCE)

Parity	B4	B3	B2	B1	Character
1	0	0	0	0	0
0	0	0	0	1	1
0	0	0	1	0	2
1	0	0	1	1	3
0	0	1	0	0	4
1	0	1	0	1	5
1	0	1	1	0	6
0	0	1	1	1	7
0	1	0	0	0	8
1	1	0	0	1	9
0	1	0	1	1	START
0	1	1	0	1	SEP
0	1	1	1	1	END

The frame leaving the interface is formed of 16 characters. Each character is made up of 5 bits according to the table on the left, where the most significant bit is **B4**, and the least significant is **B1**.

The parity bit is odd parity for **B4**, **B3**, **B2**, **B1**.

The frame is as follows: START + CHANNEL (1 character) + SEP + CODE (10 characters) + SEP + END + LRC, i.e. 16 characters altogether.

Frame construction example limited to six characters; transmitting the code "452"

MEANING	BIT	PARITY
Start	1 0 1 1	0
"4"	0 1 0 0	0
"5"	0 1 0 1	1
"2"	0 0 1 1	0
End	1 1 1 1	1
LRC	0 1 1 1	0

At the end of the frame an **LRC** control character is sent which is calculated by working out the even parity longitudinally along the corresponding bits as shown in the table on the left.

The first bit out is **B1** and the last one out is the parity bit.

Frame composition diagrams for ISO2 signals

There are three **ISO2** signals: **CLS** (Card Loading Signal), **RCP** (Read Clock Pulse) and **RDP** (Read Data Pulse). The 3 signals are active low.

First of all the **CLS** drops and after 5ms 10 clock pulse are sent; the data packet is then sent and then there is a pause of 5ms before pulling up the **CLS**.

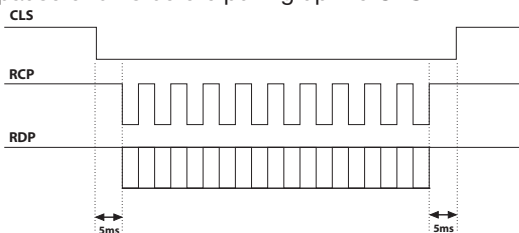

The period (T_p) has a duration of 1ms and is formed as follows:

400 μ s in which the **RDP** (data) and **RCP** (clock) lines are high

300 μ s in which the **RDP** is low if the bit is equal to 1 (**RCP** is always high)

300 μ s (T_{ck}) in which the **RCP** is low (**RDP** maintains the level it had before)

At the end of the period **RCP** and **RDP** are once again high

$T_{ck} = 300\mu s$

$T_d = 600\mu s$

$T_p = 1ms$

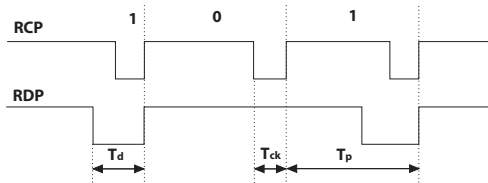

SERIAL PROTOCOL (BIT SEQUENCE)

The serial protocol sends an **RS232** standard protocol packet to the **DATA0** output (baudrate = 9600, without parity, 8 bits and one stop bit) in the following format:

00C000B₁B₂B₃B₄B₅0

where 0 is the ASCII character "0" (30h), **B₁B₂B₃B₄B₅** are the 5 least significant bits of the hexadecimal code and "C" is the transmitted channel according to the following table:

CHANNEL	CHAR
A	1 (31h)
B	2 (32h)
C	4 (34h)
D	8 (38h)

The **DATA1** output is activated 200ms before the packet is sent to **DATA0** in the following way:

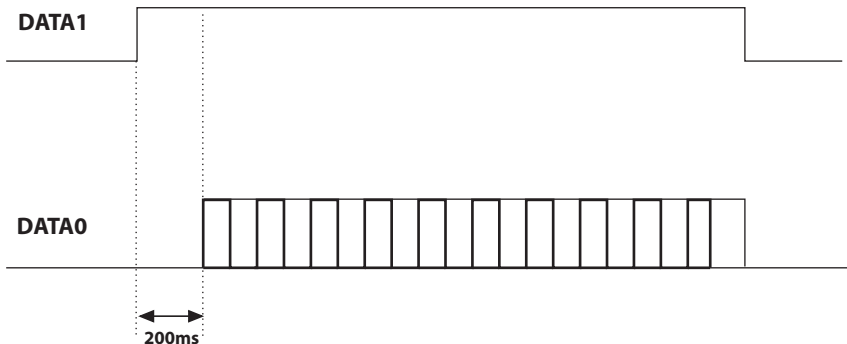

CODE TRUNCATION

If you choose the **WIEGAND** protocol 1,2,3,6,7 and 9 (pages 22...24) it is possible that the **S486** transmitter code exceeds the maximum code length that can be represented by the available bits. With jumper "**J1**" not inserted, no **WIEGAND** output will occur, code information on the **RS232** line will however be available.

Inserting jumper "**J1**" activates the "**code truncation**" function which eliminates the most significant bits which cannot be represented by the chosen **WIEGAND** format.

E.g. 1:

If you choose the 26 bit **WIEGAND** protocol with site code (limit **65'535**) and the transmitter code is **356'890**, the truncation function will cancel the first bit and the code effectively sent in **WIEGAND** output will now be **56'980** (A number less than **65'535**).

E.g. 2:

If you choose the 37 bit BCD **WIEGAND** protocol with site code (limit **542'287**) and the transmitter code is **18'436'500**, the truncation function will return the code **436'500**.



Attention! Activating the "truncation function" (jumper "**J1**" inserted) it is possible that two transmitters (even though they have different codes) send an identical sequence of bits to the interface output.

For example in the case of the **WIEGAND** 26 bit protocol with site code the codes **138'612** and **238'612** will activate the same bit sequence in output, **38'612**.

Avant de procéder à l'installation, lire attentivement ce livret. Une diverse utilisation des produits ou leur destination à un usage différent de ceux prévus et/ou conseillés n'a pas été expérimentée par le fabricant. Par conséquent, les travaux effectués sont entièrement sous la responsabilité de l'installateur. Ce livret est destiné à des personnes titulaires d'un certificat d'aptitude professionnelle pour l'installation des "APPAREILS ÉLECTRIQUES" et requiert une bonne connaissance de la technique appliquée professionnellement. Le Constructeur décline toute responsabilité pour les éventuels dommages entraînés par la non observation des normes de sécurité en vigueur actuellement durant l'installation des appareils.

Descriptif

L'interface **RCQ486W00** est un dispositif en mesure de décoder le signal provenant, par radio, d'un émetteur Cardin mod. **S486** ou, par fil, d'un clavier numérique Cardin mod. **DKS250T**, et de délivrer aux bornes de sortie un signal digital qui renferme en soi le code de l'émetteur activé selon 13 formats différents, sélectionnables au moyen d'un Dip-switch à 4 voies. Les signaux de sortie respectent les normes **ISO-3554**, inhérentes au codage sous format ABA Track (signaux **RCP, RDP, CLS**), le protocole **WIEGAND** (signaux DATA0 et DATA1 en 11 configurations possibles) ou le protocole **SÉRIEL**. Par ailleurs, il existe un contact "**EN**" permettant de brancher un temporisateur ou un interrupteur dans le but de valider ou d'invalider l'interface en différentes tranches horaires. La sortie sérielle **RS232** (indépendamment du protocole sélectionné) permet la mise en interface avec un ordinateur à travers un logiciel de gestion compris dans le kit.

Le kit comprend:

- l'interface **RCQ486W00**
- un câble sériel **RS232**
- un **CD Rom** avec le logiciel de contrôle

CARACTÉRISTIQUES TECHNIQUES

Alimentation	12/24Vac-dc
Intensité absorbée	45 mA
Portée maxi. par radio: 100 - 150 m en espace libre	
Portée maxi. par fil avec DKS250T : 150 m	
Sorties: 5V - 12V - TTL Open Collector	
Voh = 0.85 x Vdd: Vdd = 5V, Ioh = 1.2 mA maxi.	
Vdd = 12V, Ioh = 2.9 mA maxi.	
Vol = 0.4V, Iol = 15 mA maxi.	

RÉCEPTEUR

- fréquence de réception	868,3 MHz
- fréquence de l'oscillateur local	857,6 MHz
- tolérance de l'oscillateur local	±30 PPM de -20 à +75 °C
- émission de l'oscillateur local	<-57 dBm
- sensibilité (pour signal de réussite).....	-110 dBm 0,7 µV
- sélectivité.....	±30 kHz
- modulation.....	FSK
- modulation avec ΔF.....	≤20 kHz
- impédance d'entrée de l'antenne	50 Ω
- température de fonctionnement	-20° ... +75 °C

Dimensions d'encombrement

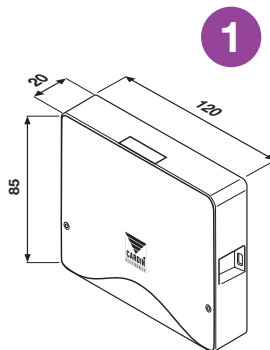

CRÉATION D'UN ACCÈS CONTRÔLÉ

En fonction de la particularité de l'installation, déterminer l'emplacement du système.
L'exemple de l'accès contrôlé illustré ci-dessous peut être utile pour choisir les composants du système. En plus du module à radiofréquence (description de ses caractéristiques techniques à la page 28) qui est compris dans le kit, il faudra avoir à disposition au moins une télécommande radio **S486** ou un clavier numérique **DKS250T**. Les commander à part en indiquant les codes suivants:

TRQ486100	Émetteurs de poche	1 fonction
TRQ486200	Émetteurs de poche	2 fonctions
TRQ486300	Émetteurs de poche	3 fonctions
TRQ486400	Émetteurs de poche	4 fonctions
TRQ48640M	Boîte à boutons radio à fixer au mur	4 fonctions
DKS250T	Clavier numérique pour montage à l'extérieur	4 fonctions



Attention! Ce livret ne contient que les instructions pour l'utilisation, la pose et la maintenance du récepteur **RCQ486W00**. Pour les instructions des autres composants du système, voir le livret fourni avec les différents produits.

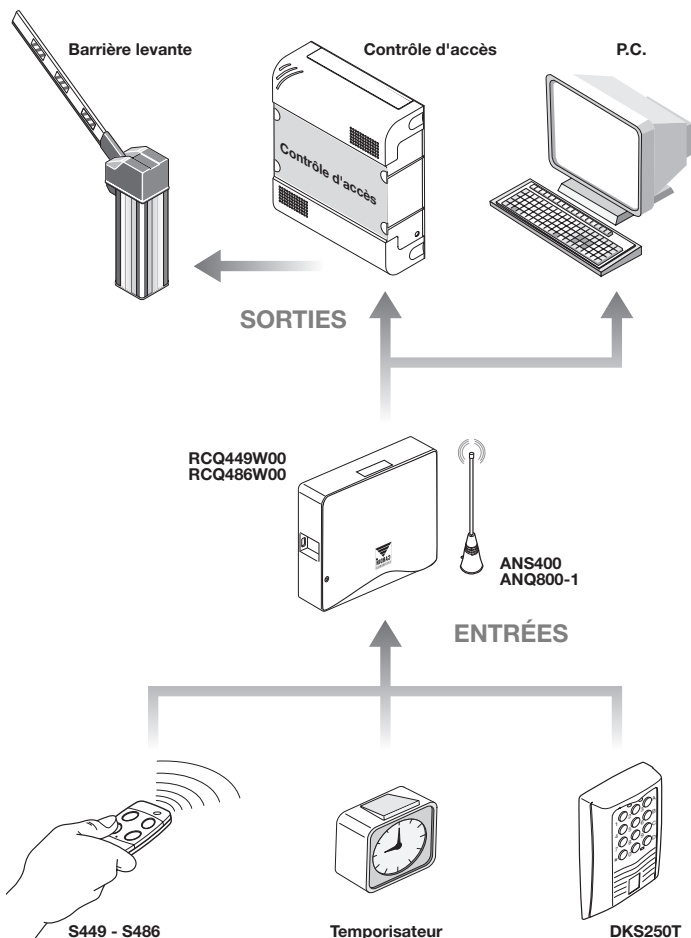

MISE EN PLACE DE L'INTERFACE MULTIPROCOLE RCQ486W00

L'interface devra être installée:

- en environnement interne (sous boîtier étanche en cas de montage à l'extérieur),
- à l'abri de chocs et d'actes de vandalisme,
- dans une position aisément accessible par le technicien chargé d'effectuer la maintenance.

Fixation:

- Dévisser les deux vis de fixation et relever le couvercle.
- Tracer (au moyen du boîtier) les deux points de fixation, et fixer le boîtier avec deux vis-tarands **M4** et relatives chevilles Fischer (hors fourniture).
- Enlever les deux protections en plastique appliquées

Branchement électrique



Attention! Alimenter l'interface exclusivement avec un alimentateur de sécurité.
Le non-respect de cette consigne peut constituer un risque.

L'interface (circuit imprimé CS1151B) est dotée d'un boîtier pour montage interne et d'un bornier à 12 vie permettant le branchement électrique:

12V ac/dc aux bornes **3-4**,

24V ac/dc aux bornes **3-5**.

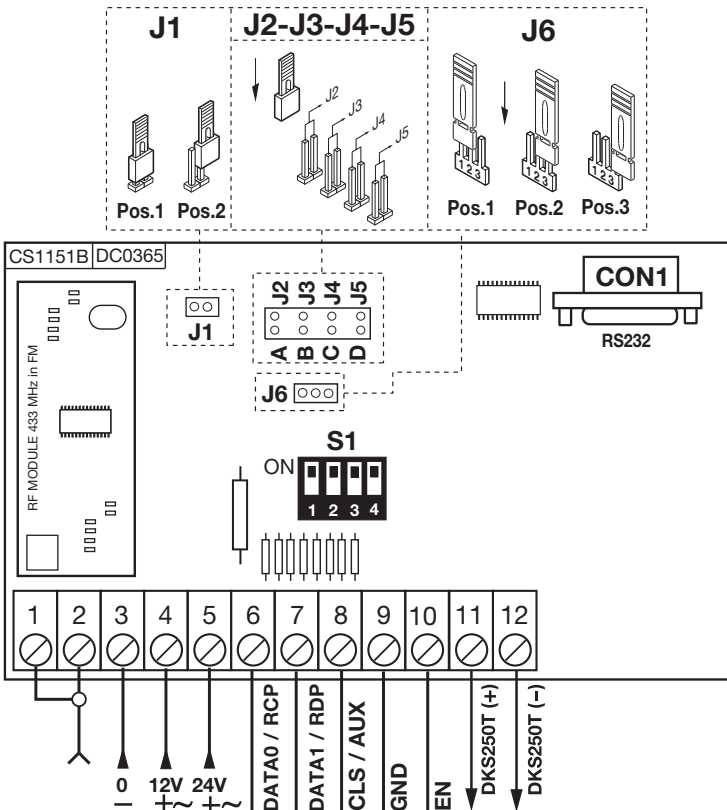

BRANCHEMENT DU CLAVIER EXTERNE DKS250T

S'il est prévu de monter un clavier numérique, procéder de la façon suivante:

- 1) Faire passer les fils de branchement "1", qui proviennent de l'interface, à travers le mur.

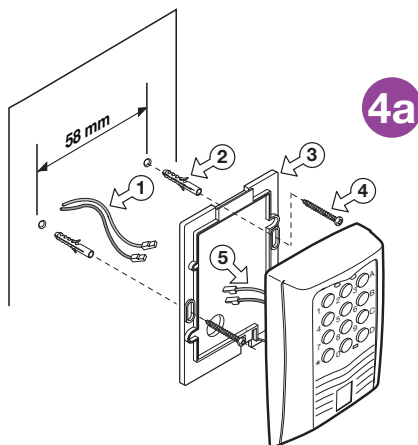

- 2) Perforer le mur en respectant la distance indiquée sur la figure 4a (58 mm).

- 3) Introduire les chevilles (fischer) "2" fournies avec le kit.

- 4) Fixer la contreplaque "3" au moyen des vis "4" fournies avec le kit.

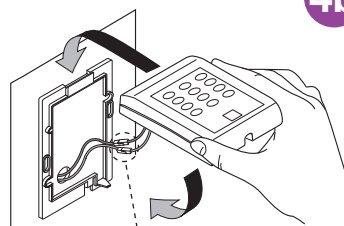



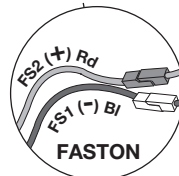

- 5) Brancher les cosses faston des fils "1" aux cosses faston du clavier "5" (fig. 4a-4b):
 - **fil rouge** du clavier à la borne 12 de l'interface,
 - **fil noir** du clavier à la borne 11 de l'interface.

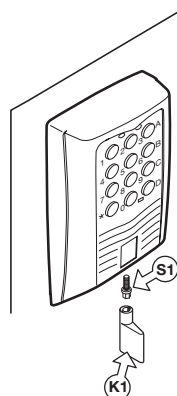

- 6) Après quoi, positionner le clavier (fig. 4b-4c) et le fixer à la contreplaque au moyen de la vis spéciale "S1" et de l'outil "K1" expressément prévu à cet effet.

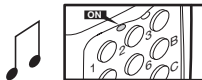

ACTIVATION DU CODE USAGER DKS250T

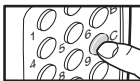
- 1  Taper sur le clavier le code numérique de l'utilisateur, et appuyer sur confirmation "*****" 
 - 2 Le clavier émet un **bip** pendant 2 secondes + LED verte allumée 
 - 3  Appuyer sur A-B-C ou D dans la colonne à droite sur le clavier (Ex. "**C**") 
- Activation exécutée!**
- 4 Après 5 secondes sans intervenir, un **bip** retentit, la LED verte s'éteint, et on quitte la programmation.

BRANCHEMENT DE L'ANTENNE EXTERNE ANQ800-1

S'il est prévu d'utiliser des télécommandes radio, l'antenne devient un élément fondamental. En effet, une fois qu'elle est raccordée au récepteur, elle représente le point de réception de la télécommande. Il est nécessaire de brancher au récepteur l'antenne **ANQ800-1** accordée, au moyen d'un câble coaxial **RG58** (impédance **50Ω**) d'une longueur maxi. de **15m**. L'antenne doit être placée à l'extérieur, à un point situé le plus haut possible, visible et éloigné de toute structure métallique.

- Brancher la masse de l'antenne à la borne "1" et le pôle à la borne "2".

BRANCHEMENT AU DISPOSITIF DE CONTRÔLE D'ACCÈS



Attention: Il faudra choisir entre "**WIEGAND, ISO2 ou SÉRIEL**", car il n'est pas possible d'utiliser simultanément plus protocoles.

Protocole WIEGAND ou SÉRIEL

Le raccordement entre le contrôle d'accès et l'interface **RCQ486W00** s'effectue aux bornes **6** (DATA 0), **7** (DATA 1) et **9** (**GND**).

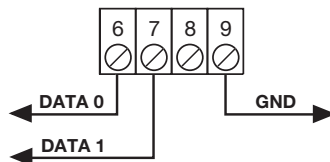

Protocole ISO2 (carte à pistes magnétiques)

Le raccordement entre le contrôle d'accès et l'interface **RCQ486W00** s'effectue aux bornes **6** (**RCP**, "read clock pulse"), **7** (**RDP**, "read data pulse"), **8** (**CLS**, "card loading signal") et **9** (**GND**).

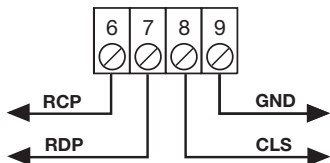

SÉLECTION DU PROTOCOLE DE SORTIE

Pour dialoguer avec une centrale de contrôle d'accès, l'interface dispose de 13 différents formats dont 11 formats **WIEGAND**, un format **ISO 2** et un format **SÉRIEL**, sélectionnables à travers le Dip-Switch "**S1**".



DIP1	DIP2	DIP3	DIP4	PROTOCOL
ON	OFF	OFF	OFF	WIEGAND 26 BIT
ON	OFF	ON	OFF	WIEGAND 26 BIT SITE
ON	OFF	ON	ON	WIEGAND 26 BIT SITE + CH
OFF	ON	OFF	OFF	WIEGAND 37 BIT
OFF	ON	OFF	ON	WIEGAND 37 BIT + CH
OFF	ON	ON	OFF	WIEGAND 37 BIT SITE
OFF	ON	ON	ON	WIEGAND 37 BIT SITE + CH
OFF	OFF	ON	OFF	WIEGAND 37 BIT D10302
OFF	OFF	ON	ON	WIEGAND 37 BIT D10302 (BCD)
ON	ON	OFF	OFF	WIEGAND 50 BIT
ON	ON	OFF	ON	WIEGAND 50 BIT + CH
OFF	OFF	OFF	ON	ISO 2
ON	ON	ON	ON	SERIAL

La séquence des bit envoyée dans les différents formats est détaillée aux pages 35...39.

SÉLECTION DE LA TENSION DE SORTIE

Le système offre trois possibilités de sélection de la tension des signaux en sortie dans les formats **WIEGAND**, **ISO2** et **SÉRIEL**:

1) **12Vdc** en sortie avec cavalier "**J6**" en position "**1**",

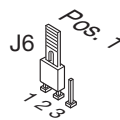

2) **5Vdc** en sortie avec cavalier "**J6**" en position "**2**",

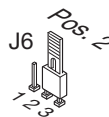

3) **TTL Open collector** en sortie avec cavalier "**J6**" en position "**3**" (contact ouvert).



VALIDATION DES CANAUX TÉLÉCOMMANDE RADIO/CLAVIER

Pour valider/invalider l'activation de la sortie sous format **WIEGAND,ISO2** ou **SÉRIEL** connecter les cavaliers "**J2**", "**J3**", "**J4**" et "**J5**" de la façon suivante:

1) Avec cavalier "**J2**" connecté, le canal "**A**" de l'émetteur **S486** ou du clavier **DKS250T** active la fonction "**A**" du récepteur **RCQ486W00**. Tous les autres canaux sont invalidés.

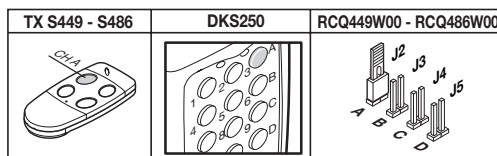

2) Avec cavalier "**J3**" connecté, le canal "**B**" de l'émetteur **S486** ou du clavier **DKS250T** active la fonction "**B**" du récepteur **RCQ486W00**. Tous les autres canaux sont invalidés.

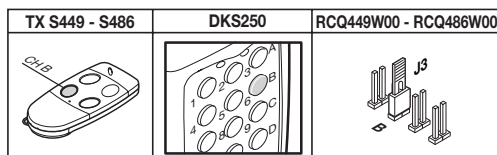

3) Avec cavalier "**J4**" connecté, le canal "**C**" de l'émetteur **S486** ou du clavier **DKS250T** active la fonction "**C**" du récepteur **RCQ486W00**. Tous les autres canaux sont invalidés.

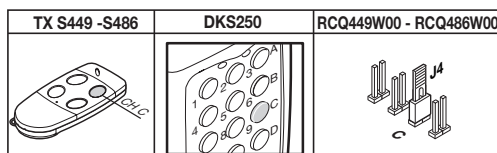

4) Avec cavalier "**J5**" connecté, il canal "**D**" de l'émetteur **S486** ou du clavier **DKS250T** active la fonction "**D**" du récepteur **RCQ486W00**. Tous les autres canaux sont invalidés.

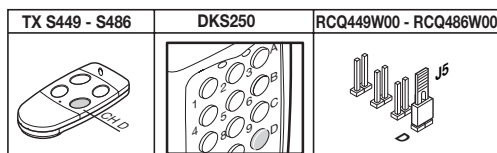

5) Avec cavaliers "**J2**" et "**J5**" connectés, les canaux "**A**" et "**D**" de l'émetteur **S486** ou du clavier **DKS250T** activent respectivement les fonctions "**A**" et "**D**" du récepteur **RCQ486W00**. Tous les autres canaux sont invalidés.

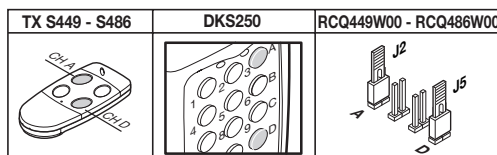

Toutes les combinaisons, jusqu'à un maximum de 4 touches de canal, sont possibles.

VALIDATION PAR TEMPORASITEUR

En branchant un temporisateur ou un simple interrupteur aux bornes 9 et 10, il est possible de valider ou d'invalider l'interface en différentes tranches horaires. Exemple: si aucune personne n'est autorisée à entrer dans la zone ou dans l'établissement contrôlé après 22 H, il suffit de programmer le temporisateur de façon à ce qu'il ouvre le contact "**EN**" après cette heure.

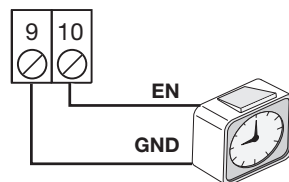

Attention: si aucun dispositif n'est branché aux bornes **9** et **10**, le contact **doit être** court-circuité. L'interface n'active pas la sortie **WIEGAND/ISO2/SÉRIEL** si ce contact est ouvert.

LOGICIEL D'INTERFACE SUR PC

En branchant un ordinateur au récepteur **RCQ486W00** au moyen de l'interface **RS232**, et en installant le logiciel de gestion fourni sur **CD Rom** (le câble et le **CD Rom** sont fournis avec le kit), il est possible d'avoir une liste des évènements (c'est-à-dire les entrées et les sorties quotidiennes du système). Pour plus de détails sur le logiciel, voir le livret d'instructions sous format PDF sur le **CD Rom** même.

PROTOCOLE WIEGAND (SÉQUENCES DE BIT)

Nota 1: Dans la séquence de bit envoyés en sortie, le premier qui est transmis est le bit 1.

1) WIEGAND 26 bit

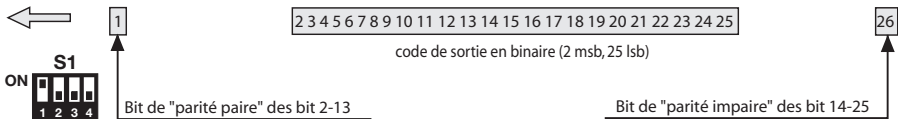

Attention! Le code est limité à **16'777'215**. Pour utiliser des codes avec un nombre plus grand, voir à la page 40 le paragraphe "**Abréviation du code**"

2) WIEGAND 26 bit avec code du site

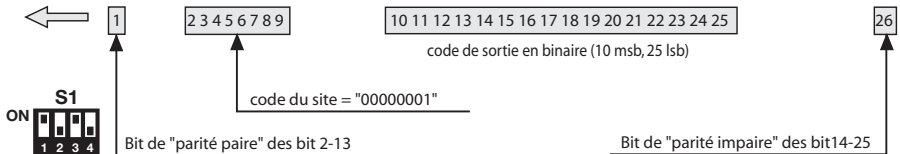

Attention! Le code est limité à **65'535**. Pour utiliser des codes avec un nombre plus grand, voir à la page 40 le paragraphe "**Abréviation du code**".

3) WIEGAND 26 bit avec code du site et information de canal

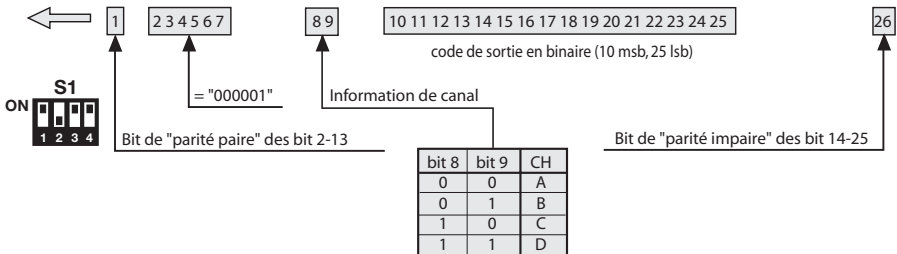

Attention! Le code est limité à **65'535**. Pour utiliser des codes avec un nombre plus grand, voir à la page 40 le paragraphe "**Abréviation du code**".

4) WIEGAND 37 bit

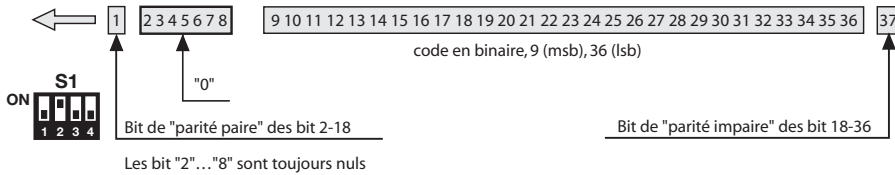

5) WIEGAND 37 bit avec information de canal

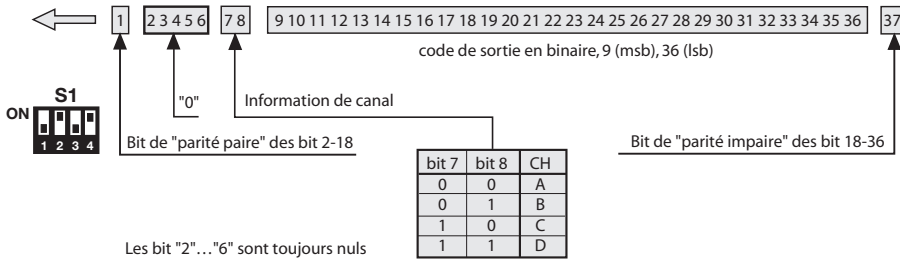

6) WIEGAND 37 bit avec code du site

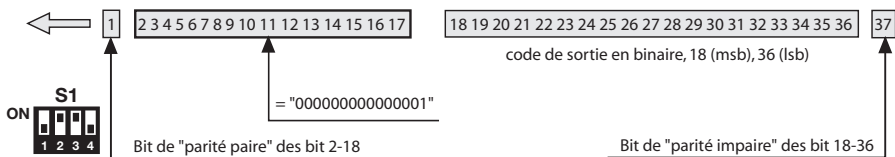

Attention! Le code est limité à **524'287**. Pour utiliser des codes avec un nombre plus grand, voir à la page 40 le paragraphe "**Abréviation du code**".

7) WIEGAND 37 bit avec code du site et information de canal

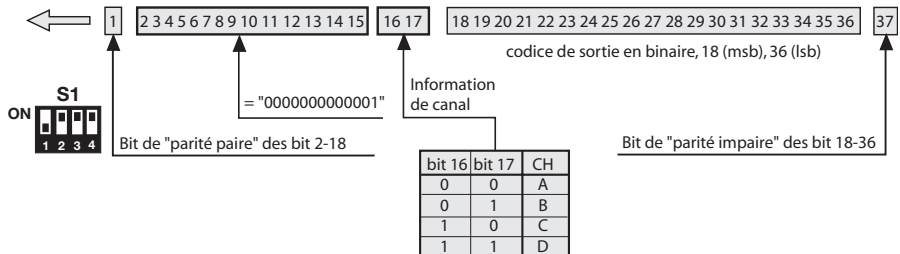

Attention! Le code est limité à **524'287**. Pour utiliser des codes avec un nombre plus grand, voir à la page 40 le paragraphe "**Abréviation du code**".

8) WIEGAND 37 bit D10302

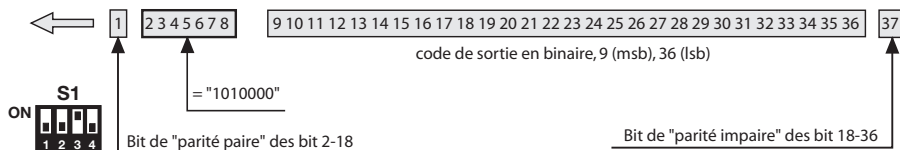

9) WIEGAND 37 bit D10302 (BCD)

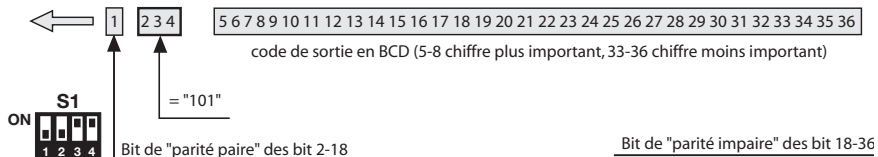

Attention! Le code est limité à **99'999'999**. Pour utiliser des codes avec un nombre plus grand, voir à la page 40 le paragraphe "**Abréviation du code**".

10) WIEGAND 50 bit

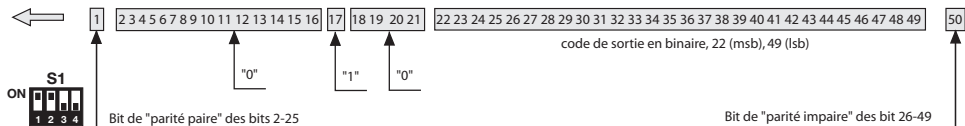

11) WIEGAND 50 bit + information de canal

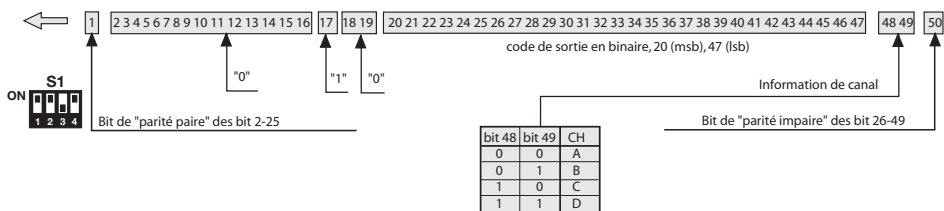

Diagrammes temporels des signaux WIEGAND

La trame en format **WIEGAND** est émise à travers les signaux **DATA0** et **DATA1**. La durée de chaque bit est de 50µs, tandis que l'intervalle entre un bit et l'autre est de 2ms.

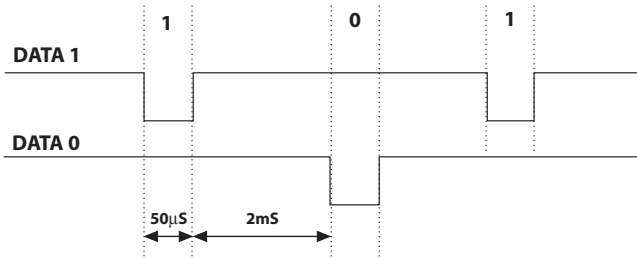

PROTOCOLE ISO2 (SÉQUENCES DE BIT)

Parity	B4	B3	B2	B1	Character
1	0	0	0	0	0
0	0	0	0	1	1
0	0	0	1	0	2
1	0	0	1	1	3
0	0	1	0	0	4
1	0	1	0	1	5
1	0	1	1	0	6
0	0	1	1	1	7
0	1	0	0	0	8
1	1	0	0	1	9
0	1	0	1	1	START
0	1	1	0	1	SEP
0	1	1	1	1	END

La trame à la sortie de l'interface est composée de 16 caractères. Chaque caractère est constitué de 5 bit selon le codage du tableau, où le bit plus important est **B4**, et le moins important **B1**.

Le bit de parité est la parité impaire de **B4**, **B3**, **B2**, et **B1**.

La trame est la suivante: START + CANAL (1 caractère) + SEP + CODE (10 caractères) + SEP + END + LRC, c'est-à-dire 16 caractères en tout.

Exemple de construction de la trame constituée d'un maximum de 6 caractères; transmission du code "452"

MEANING	BIT	PARITY
Start	1 0 1 1	0
"4"	0 1 0 0	0
"5"	0 1 0 1	1
"2"	0 0 1 1	0
End	1 1 1 1	1
LRC	0 1 1 1	0

Le caractère de contrôle **LRC** est envoyé à la fin de la trame. Celui-ci est calculé en faisant la parité paire dans le sens longitudinal (sur les colonnes) des bit correspondant, ainsi qu'il est indiqué sur le tableau. Le premier bit à sortir est **B1** et le dernier celui de parité.

Diagrammes temporels des signaux ISO2

Les signaux **ISO2** sont au nombre de 3: **CLS** (Card Loading Signal), **RCP** (Read Clock Pulse) et **RDP** (Read Data Pulse).

Les 3 signaux sont actifs bas. En premier lieu, on abaisse **CLS** et, après 5ms, on envoie 10 "coups" de clock, et ensuite le paquet de données. Après quoi, on attend 5ms avant d'élever **CLS**.

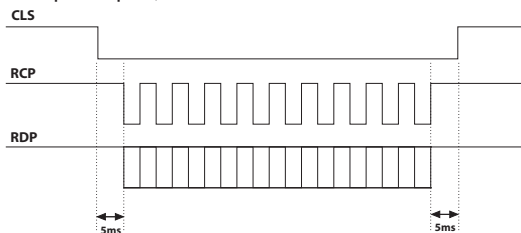

La période (T_p) dure 1ms, et est constituée de la façon suivante:
400µs où les lignes **RDP** (données) et **RCP** (clock) sont hautes,
300µs où la ligne **RDP** est basse si le bit vaut 1 (**RCP** est encore haute),
300µs (T_{ck}) où la ligne **RCP** est basse (**RDP** maintient le niveau d'avant).
 À la fin de la période, **RCP** et **RDP** reviennent au niveau haut.

$T_{ck} = 300\mu s$

$T_d = 600\mu s$

$T_p = 1ms$

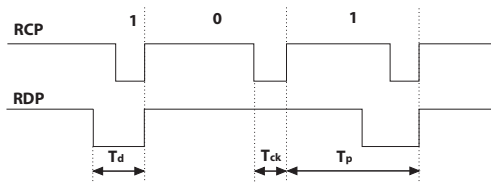

PROTOCOLE SÉRIEL (SÉQUENCES DE BIT)

Le protocole sériel présente à la sortie de la borne **DATA0** le protocole standard **RS232** (baudrate = 9600, sans parité, 8 bit, et un bit de stop) dans le format suivant:
 00C000B₁B₂B₃B₄B₅0

où 0 est le caractère ASCII "0" (30h), **B₁B₂B₃B₄B₅** sont les 5 chiffres moins importants du code en système hexadécimal et "C" représente le canal transmis selon le tableau:

CANALE	CAR
A	1 (31h)
B	2 (32h)
C	4 (34h)
D	8 (38h)

La sortie **DATA1** est activée **200ms** avant d'envoyer les données à la sortie **DATA0** de la façon suivante:

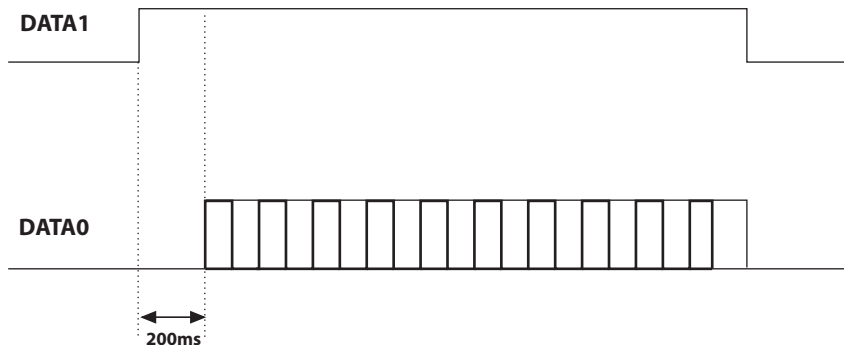

ABRÉVIATION DU CODE

En choisissant le protocole **WIEGAND** 1,2,3,6,7 et 9 (pages 35...37), il est possible que le code de l'émetteur S486 soit supérieur au code maximum représentable avec les bit à disposition.

Avec cavalier "**J1**" déconnecté, aucune sortie **WIEGAND** ne sera activée; l'information sur le code reçu sera disponible sur la sortie **RS232**.

En connectant le cavalier "**J1**", on active la fonction "**abréviation code**", qui éliminera les bit plus importants qui ne peuvent pas être représentés dans le format **WIEGAND** sélectionné.

Ex 1:

En sélectionnant le protocole **WIEGAND** 26 bit avec code du site (limite **65.535**) et le code de l'émetteur est **356.890**, la fonction d'abréviation effacera le bit avant et le code qui sera envoyé à la sortie **WIEGAND** sera donc **56.980** (Nombre inférieur à **65.535**)

Ex 2:

En sélectionnant le protocole **WIEGAND** 37 bit BCD code du site (limite **542.287**) et le code de l'émetteur est **18,436.500**, la fonction d'abréviation restituera le code **436.500**.



Attention! En activant la fonction "Abréviation code" (cavalier "**J1**" fermé), il est possible que deux émetteurs activent, même si leur code est différent, à la sortie de l'interface, une séquence de bit identique.

Par exemple, en cas du format **WIEGAND** 26 bit avec code SITO, les codes **138'612** et **238'612** activent en sortie la même séquence de bit, **38'612**.

Bevor mit der Installation begonnen wird, sollte das vorliegende Heft aufmerksam gelesen werden. Die Anwendung und Nutzung der Produkte zu einem anderen Zweck, als es vorgesehen und/oder geraten wurde, ist nicht vom Hersteller erprobt worden. Die Installationsarbeiten erfolgen daher unter der vollständigen Verantwortung des Installateurs. Das vorliegende Handbuch wendet sich an Personen, die zur Installation von "**ELEKTROGERÄTEN**" befähigt sind und setzt gute technische Kenntnisse voraus. Der Hersteller lehnt jegliche Verantwortung für eventuelle Schäden ab, die durch die fehlende Beachtung der zur Zeit geltenden Sicherheitsnormen bei der Installation entstanden sind.

Beschreibung

Die Schnittstelle **RCQ486W00** ist eine Vorrichtung, die in der Lage ist, ein über Funk von einem Cardin Sender Mod. **S486** gesendetes oder über Kabel von einer numerischen Cardin Tastatur Mod. **DKS250T** eingegebenes Signal zu dekodifizieren und es dann an den Ausgangsklemmen in digitaler Form vorzugeben. Das digitale Signal beinhaltet eine Datenreihe mit dem Code des aktivierten Senders in 13 verschiedenen Formaten, die mittels eines 4-Wege-Dip-Schalters wählbar sind. Für die Ausgangssignale werden die Normen **ISO-3554** für die Kodifizierung im Format ABA Track (Signale **RCP**, **RDP**, **CLS**), das **WIEGAND-Protokoll** (Signale DATA0 und DATA1 in 11 möglichen Konfigurationen) oder das **SERIELLE-Protokoll** angewandt. Desweiteren steht ein "**EN**"-Kontakt zur Verfügung, an den ein Zeitschalter oder ein Schalter zur zeitgesteuerten Freigabe oder Sperrung der Schnittstelle angeschlossen werden kann. Der serielle Ausgang **RS232** (unabhängig vom gewählten Protokoll) zusammen mit einem mitgelieferten Verwaltungsprogramm gestattet den Anschluss an einen Personal Computer.

Der Bausatz beinhaltet:

- die Schnittstelle **RCQ486W00**
- ein serielles Kabel **RS232**
- eine **CD Rom** mit dem Kontroll-Software

TECHNISCHE DATEN

Stromversorgung 12/24Vac-dc
 Stromaufnahme 45 mA

Maximale Reichweite über Funk: 100 - 150 m. im freien Raum

Maximale Reichweite über Kabel mit **DKS250T**: 150 m

Ausgang : 5V - 12V - TTL Open Collector

Voh = 0.85 x Vdd: Vdd = 5V, Ioh = 1.2 mA max

Vdd = 12V, Ioh = 2.9 mA max

Vol = 0.4V, Iol = 15 mA max

Empfänger

- Empfangsfrequenz 868,3 MHz
- Frequenz des örtlichen Oszillators 857,6 MHz
- Toleranz des örtlichen Oszillators ±30 PPM von -20 bis +75 °C
- Emission des örtlichen Oszillators < -57 dBm
- Empfindlichkeit (für das gültige Eingangssignal) -110 dBm 0,7 µV
- Trennschärfe ±30 kHz
- Modulation FSK
- Modulation mit ΔF ≤20 kHz
- Impedanz Antenneneingang 50 Ω
- Betriebstemperatur -20° ... +75 °C

Aussenabmessungen

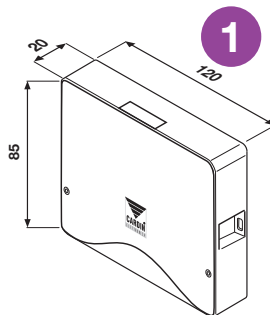

ERSTELLUNG EINES EINFAHRTKONTROLLSYSTEMS

Anhand der Typologie und Eigenschaften der Anlage die Einbaustelle des Systems bestimmen. Das untengezeigte Beispiel eines Einfahrtkontrollsystems kann bei der Wahl der Systembestandteile von Nutzen sein. Obwohl das Funkmodul (mit den auf Seite 41 beschriebenen technischen Daten) mit zum Bausatz gehört, muss mindestens eine Funksteuerung **S486** oder eine numerische Tastatur **DKS250T** mit den nachstehend aufgeführten Kenn-Nummern separat gekauft werden.

TRQ486100	Handsender	1 Funktion
TRQ486200	Handsender	2 Funktionen
TRQ486300	Handsender	3 Funktionen
TRQ486400	Handsender	4 Funktionen
TRQ48640M	Wandsender	4 Funktionen
DKS250T	Nummer-Schloss (außenanwendung)	4 Funktionen



Achtung! Dieses Handbuch enthält die Bedienungs-, Installations- und Wartungsanleitung nur für den Empfänger **RCQ486W00**. Für die Anleitungen der anderen Systemkomponenten muss im mit dem jeweiligen Produkt mitgelieferten Handbuch nachgeschlagen werden.

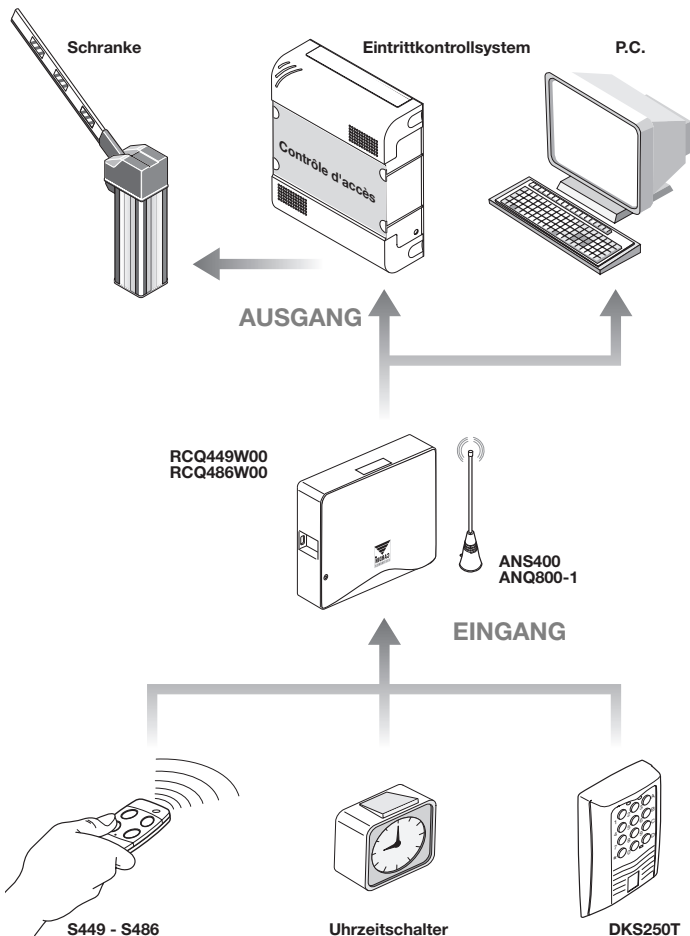

INSTALLATION DER MULTIPROTOKOLL-SCHNITTSTELLE RCQ486W00

Die Schnittstelle sollte installiert werden:

- in Innenräumen (wenn im Freien, in einem wasserdichten Gehäuse unterbringen);
- Geschützt vor Stößen und mutwilliger Beschädigung;
- in einer für den Techniker zwecks Wartungsarbeiten leicht zugänglichen Position.

Befestigung:

- Die beiden Befestigungsschrauben losschrauben und den Deckel anheben.
- Die beiden Befestigungspunkte (mit Hilfe der Schachtel) anzeichnen und das Gehäuse mit den beiden selbstschneidenden Schrauben **M4** und Fischerdübeln (werden nicht mitgeliefert) anbringen.
- Die beiden Schutzabdeckungen aus Kunststoff an den Kabeleinlässen entfernen.

Elektrischer Anschluss



Achtung: Zur Versorgung der Schnittstelle ausschließlich ein Sicherheitspeisegerät verwenden. Die Verwendung eines andersartigen Speisegerätes kann gefährlich sein.

Die Schnittstelle (gedruckter Schaltkreis CS1151B) ist mit einem Innengehäuse und einer 12-Wege-Anschlussklemmleiste mit Stromanschluss ausgestattet:

12V ac/dc zwischen den Klemmen **3-4**

24V ac/dc zwischen den Klemmen **3-5**

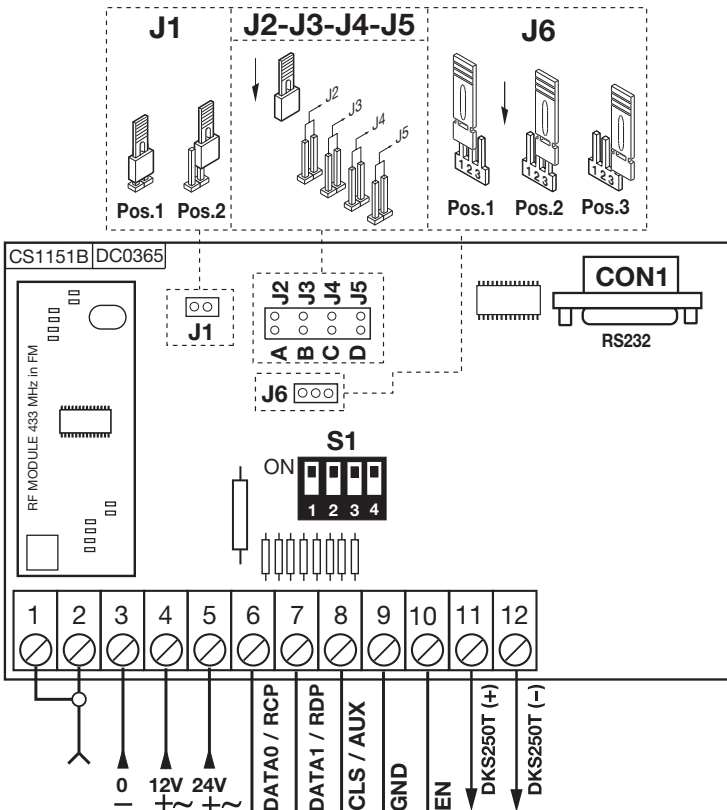

ANSCHLUSS DER EXTERNEN TASTATUR DKS250T

Falls die Installation einer externen numerischen Tastatur vorgesehen ist, sollte wie folgt verfahren werden:

1) Die von der Schnittstelle kommenden Anschlusskabel "1" durch die Mauer führen.

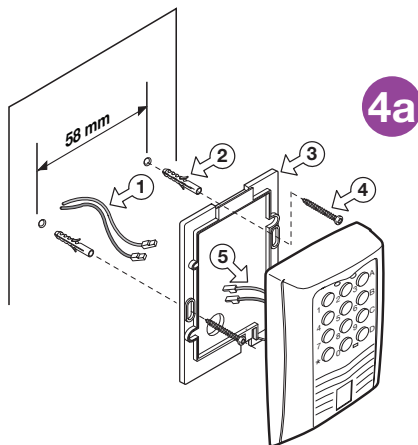

2) Die Mauer in dem wie in der Abbildung 4a angezeigten Abstand (58 mm) anbohren.

3) Die mit dem Bausatz mitgelieferten Fischer-Dübel "2" einstecken.

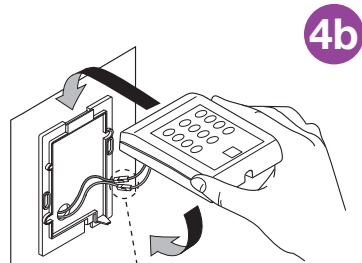

4) Die Befestigungsplatte "3" mit den im Bausatz mitgelieferten Schrauben "4" befestigen.

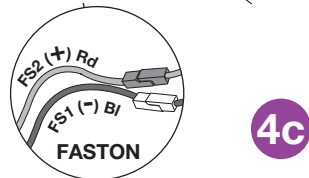

5) Die Fastons der Kabel "1" mit den Fastons der Tastatur "5" (Abb. 4a-4b) verbinden:

- rote Leitung von der Tastatur an die Anschlussklemme 12 der Schnittstelle
- schwarze Leitung von der Tastatur an die Anschlussklemme 11 der Schnittstelle

6) Nun die Tastatur positionieren (Abb. 4b-4c) und mit der Spezialschraube "S1" unter Verwendung des dafür vorgesehenen Werkzeuges "K1" an der Befestigungsplatte befestigen.

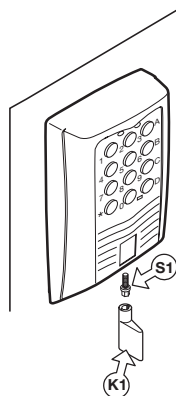

AKTIVIERUNG DES BENUTZER-CODES DKS250T

- 1  Auf der Tastatur den numerischen Benutzer-Code eingeben und die Bestätigungstaste "*" drücken



- 2 Die Tastatur gibt 2 Sekunden lang einen **Beep-Ton** von sich und die grüne LED leuchtet auf

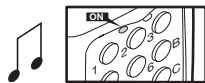

- 3  A-B-C oder D rechts auf der Tastatur drücken (z.B. "C").

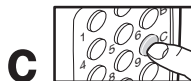

Aktivierung ausgeführt!

- 4 Nach einer Inaktivität von 5 Sekunden ertönt ein **Beep-Ton**. Die grüne LED erlischt und es erfolgt der Austritt aus der Modalität.

ANSCHLUSS DER EXTERNEN ANTENNE ANQ800-1

Falls die Verwendung von Funksteuerungen vorgesehen ist, wird die Installation der Antenne unerlässlich, da sie in Verbindung mit dem Empfänger den Empfangspunkt für die Funksteuerung darstellt. An den Empfänger muss die abgestimmte Antenne **ANQ800-1** mit einem Koaxialkabel **RG58** (Impedanz **50Ω**), das nicht länger als **15 m** sein darf, angeschlossen werden. Die Antenne muss außen am höchsten Punkt, gut sichtbar und weit entfernt von Metallstrukturen positioniert werden.

- Den Außenleiter der Antenne an die Klemme "1" und den Innenleiter an die Klemme "2" anschließen.

ANSCHLUSS AN DAS EINFAHRTSKONTROLLSYSTEM



Achtung: Die Wahl muss zwischen die Protokollen "**WIEGAND**, **ISO2** oder **SERIELL**" getroffen werden. Es können nicht mehrere Protokolle gleichzeitig verwendet werden.

WIEGAND-Protokoll oder SERIELLE

Der effektive Anschluss zwischen der Einfahrtskontrolle und der Schnittstelle **RCQ486W00** erfolgt über die Klemmen:

6 (DATA 0), **7 (DATA 1)** und **9 (GND)**

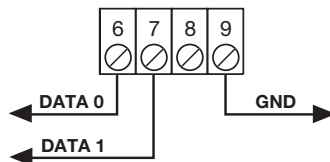

ISO2-Protokoll (Magnetstreifen)

Der effektive Anschluss zwischen der Einfahrtskontrolle und der Schnittstelle **RCQ486W00** erfolgt über die Klemmen: **6 (RCP, "read clock pulse")**, **7 (RDP, "read data pulse")**, **8 (CLS, "card loading signal")** und **9 (GND)**

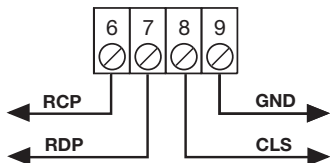

WAHL DES AUSGANGSPROTOKOLLS

Die Schnittstelle verfügt über 13 verschiedene Formate zur Kommunikation mit einer Einfahrtskontrollsteuerung. Es stehen 11 Formate für **WIEGAND**, ein Format für **ISO 2** und ein **SERIELLE** Format zur Verfügung, die mittels dem Dip-Schalter "S1" gewählt werden können.

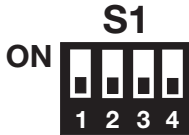

DIP1	DIP2	DIP3	DIP4	PROTOCOL
ON	OFF	OFF	OFF	WIEGAND 26 BIT
ON	OFF	ON	OFF	WIEGAND 26 BIT SITE
ON	OFF	ON	ON	WIEGAND 26 BIT SITE + CH
OFF	ON	OFF	OFF	WIEGAND 37 BIT
OFF	ON	OFF	ON	WIEGAND 37 BIT + CH
OFF	ON	ON	OFF	WIEGAND 37 BIT SITE
OFF	ON	ON	ON	WIEGAND 37 BIT SITE + CH
OFF	OFF	ON	OFF	WIEGAND 37 BIT D10302
OFF	OFF	ON	ON	WIEGAND 37 BIT D10302 (BCD)
ON	ON	OFF	OFF	WIEGAND 50 BIT
ON	ON	OFF	ON	WIEGAND 50 BIT + CH
OFF	OFF	OFF	ON	ISO 2
ON	ON	ON	ON	SERIAL

Für eine ausführliche Erklärung der in den verschiedenen Formaten gesendeten Bit-Sequenz auf Seite 48-52 nachschlagen.

WAHL DER AUSGANGSSPANNUNG

Die Spannung der Ausgangssignale in den Formaten **WIEGAND**, **ISO 2** und **SERIELLE** kann auf drei Weisen gewählt werden:

1) 12Vdc am Ausgang mit Jumper "J6" in Position "1"

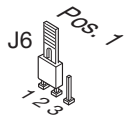

2) 5Vdc am Ausgang mit Jumper "J6" in Position "2"

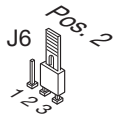

3) TTL Open collector am Ausgang mit Jumper "J6" in Position "3"
(offener Kontakt)

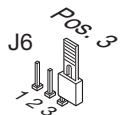

FREIGABE DER KANÄLE FUNKSTEUERUNG/TASTATUR

Zur Freigabe/Sperrung der Aktivierung des Ausgangs in den Formaten **WIEGAND**, **ISO2** oder **SERIELLE** die Jumper "**J2**", "**J3**", "**J4**", "**J5**" in der folgenden Weise einsetzen:

- 1) Bei Einsetzung von Jumper "**J2**" aktiviert der Kanal "**A**" des Senders **S486** oder der Tastatur **DKS250T** die Funktion "**A**" des Empfängers **RCQ486W00**. Alle anderen Kanäle sind gesperrt.

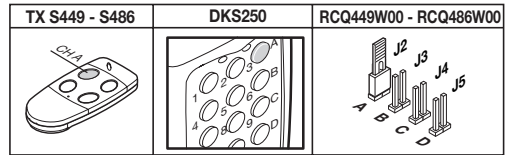

- 2) Bei Einsetzung von Jumper "**J3**" aktiviert der Kanal "**B**" des Senders **S486** oder der Tastatur **DKS250T** die Funktion "**B**" des Empfängers **RCQ486W00**. Alle anderen Kanäle sind gesperrt.

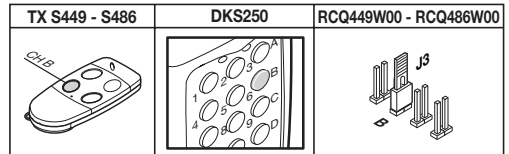

- 3) Bei Einsetzung von Jumper "**J4**" aktiviert der Kanal "**C**" des Senders **S486** oder der Tastatur **DKS250T** die Funktion "**C**" des Empfängers **RCQ486W00**. Alle anderen Kanäle sind gesperrt.

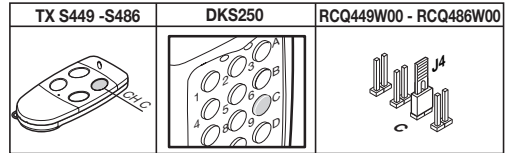

- 4) Bei Einsetzung von Jumper "**J5**" aktiviert der Kanal "**D**" des Senders **S486** oder der Tastatur **DKS250T** die Funktion "**D**" des Empfängers **RCQ486W00**. Alle anderen Kanäle sind gesperrt.

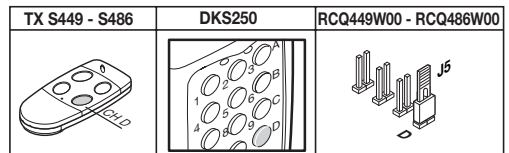

- 5) Bei Einsetzung von Jumper "**J2**" und "**J5**" aktivieren die Kanäle "**A**" und "**D**" des Empfängers **S486** oder der Tastatur **DKS250T** die Funktionen "**A**" und "**D**" des Empfängers **RCQ486W00**. Alle anderen Kanäle sind gesperrt.

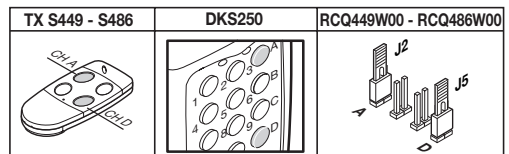

Alle Kombinationsmöglichkeiten bis zu einer Höchstzahl von 4 Kanaltasten stehen zur Verfügung.

FREIGABE MIT UHRZEITSCHALTER

Durch den Anschluss eines Uhrzeitschalters oder eines einfachen Schalters an die Klemmen 9 und 10 besteht die Möglichkeit die Schnittstelle zu verschiedenen Zeiten freizugeben oder zu sperren. Beispiel: Wenn niemand in den Bereich oder in das kontrollierte Werkgelände nach 22.00 Uhr einfahren darf, braucht nur der Uhrzeitschalter so eingestellt zu werden, dass er den Kontakt "**EN**" nach dieser Uhrzeit öffnet.

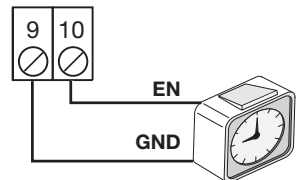

Achtung: Wenn keine Vorrichtung an die Klemmen **9** und **10** angeschlossen wird, **müssen** die beiden Klemmen mit einer Überbrückung verbunden werden. Die Schnittstelle aktiviert den Ausgang **WIEGAND/ISO2/SERIELL** mit diesem offenen Kontakt nicht.

SCHNITTSTELLEN-SOFTWARE FÜR PC

Durch den Anschluss eines PC an den Empfänger **RCQ486W00** mittels der Schnittstelle **RS232** und der Installation der auf **CD Rom** gelieferten Verwaltungssoftware (das Kabel und die **CD Rom** werden mit dem Bausatz mitgeliefert) kann eine Liste der Ereignisse (d.h. der täglichen Ein- und Ausfahrten in bzw. aus dem System) aufgestellt werden. Zur ausführlichen Erläuterung der Software muss das im PDF-Format auf dem **CD Rom** gespeicherte Handbuch zu Rate gezogen werden.

WIEGAND-PROTOKOLL (BIT-SEQUENZ)

Anmerkung 1: Bei der Sequenz der am Ausgang abgesandten Bits ist der erste gesendete Bit der Bit 1.

1) WIEGAND 26 bit

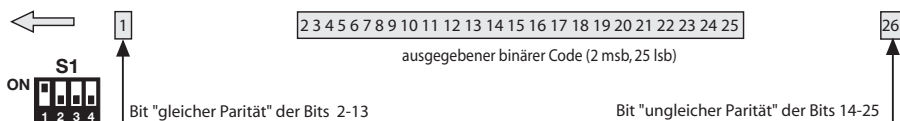

Achtung! Der Code kann nicht größer als **16'777'215** sein. Wenn Codes mit größeren Zahlen verwendet werden sollen, auf Seite 53 die Anmerkung **"Code-Abtrennung"** lesen.

2) WIEGAND 26 bit mit Aufstellercode

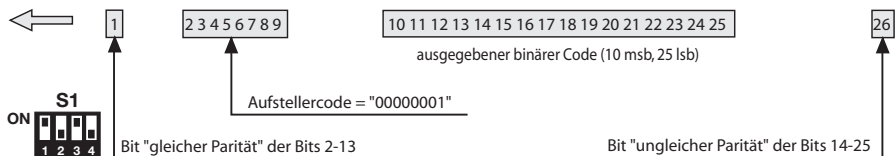

Achtung! Der Code kann nicht größer als **65'535** sein. Wenn Codes mit größeren Zahlen verwendet werden sollen, auf Seite 53 die Anmerkung **"Code-Abtrennung"** lesen.

3) WIEGAND 26 bit mit Aufstellercode und Kanal-Information

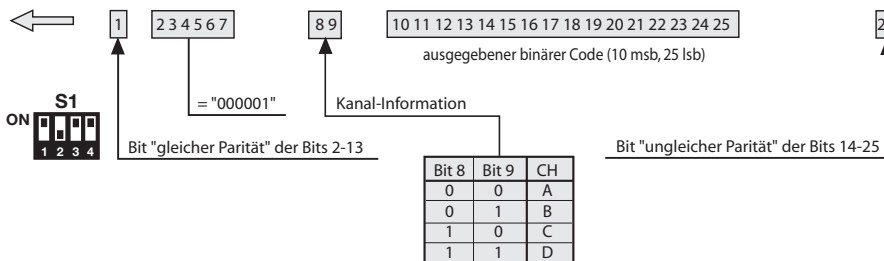

Achtung! Der Code kann nicht größer als **65'535** sein. Wenn Codes mit größeren Zahlen verwendet werden sollen, auf Seite 53 die Anmerkung **"Code-Abtrennung"** lesen.

4) WIEGAND 37 bit

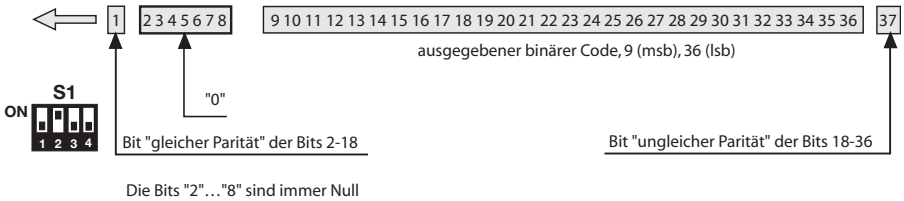

5) WIEGAND 37 bit mit Kanal-Information

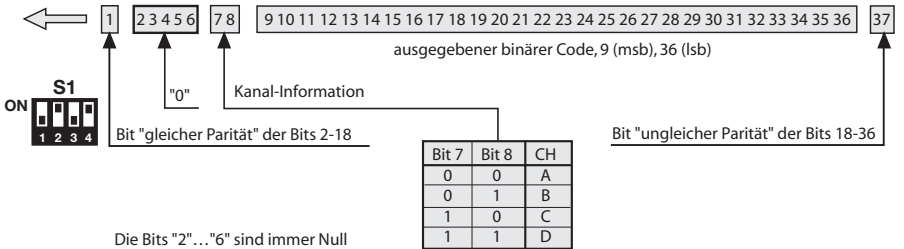

6) WIEGAND 37 bit mit Aufstellercode

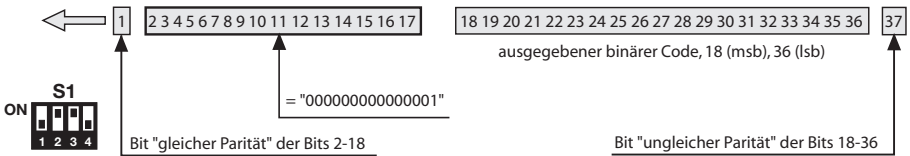

Achtung! Der Code kann nicht größer als **524'287** sein. Wenn Codes mit größeren Zahlen verwendet werden sollen, auf Seite 53 die Anmerkung "**Code-Abtrennung**" lesen.

7) WIEGAND 37 bit mit Aufstellercode und Kanal-Information

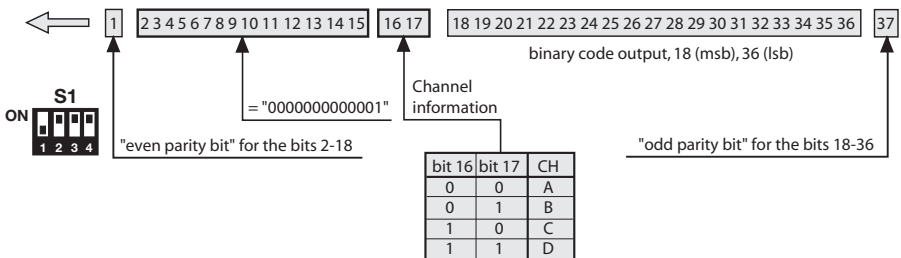

Achtung! Der Code kann nicht größer als **524'287** sein. Wenn Codes mit größeren Zahlen verwendet werden sollen, auf Seite 53 die Anmerkung "**Code-Abtrennung**" lesen.

8) WIEGAND 37 bit D10302

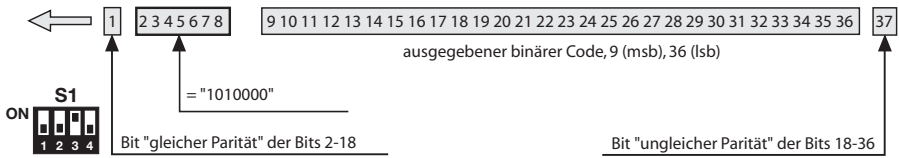

9) WIEGAND 37 bit D10302 (BCD)

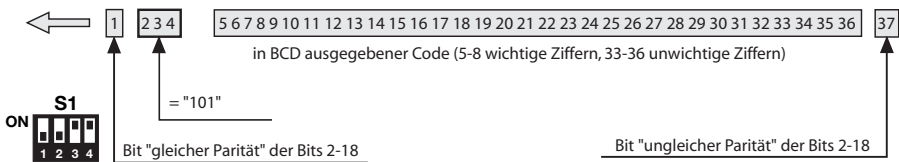

Achtung! Der Code kann nicht größer als **99'999'999'** sein. Wenn Codes mit größeren Zahlen verwendet werden sollen, auf Seite 53 die Anmerkung **"Code-Abtrennung"** lesen.

10) WIEGAND 50 bit

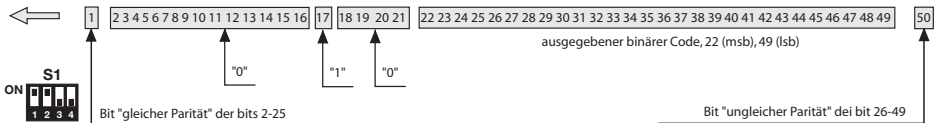

11) WIEGAND 50 bit mit Kanal-Information

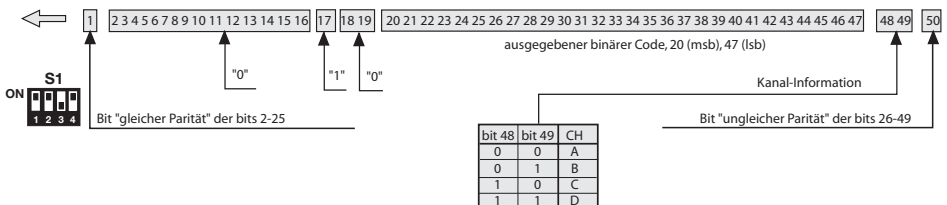

Zeitdiagramme der WIEGAND-Signale

Die Datenreihe im **WIEGAND**-Format wird durch die Signale **DATA0** und **DATA1** ausgegeben. Die Dauer des einzelnen Bits beträgt $50\mu\text{s}$, während die Wartezeit zwischen einem Bit und dem darauffolgenden 2ms beträgt.

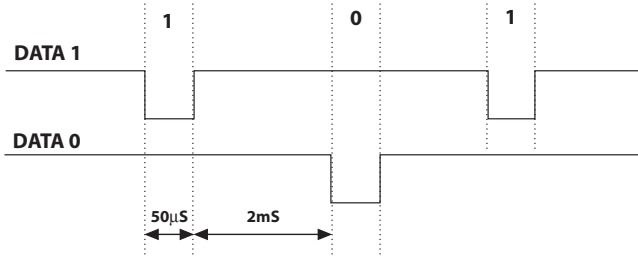

ISO2-PROTOKOLL (BIT-SEQUENZ)

Parität	B4	B3	B2	B1	Carattere
1	0	0	0	0	0
0	0	0	0	1	1
0	0	0	1	0	2
1	0	0	1	1	3
0	0	1	0	0	4
1	0	1	0	1	5
1	0	1	1	0	6
0	0	1	1	1	7
0	1	0	0	0	8
1	1	0	0	1	9
0	1	0	1	1	START
0	1	1	0	1	SEP
0	1	1	1	1	END

Die von der Schnittstelle ausgegebene Datenreihe besteht aus 16 Zeichen. Wie aus der Tabelle ersichtlich besteht jedes Zeichen aus 5 Bit, wobei der bedeutendste Bit **B4** und der unbedeutendste **B1** ist.

Der Paritätsbit ist die ungleiche Parität von **B4**, **B3**, **B2**, **B1**.

Die Datenreihe ist die folgende: START + KANAL (1 Zeichen) + SEP + CODE (10 Zeichen) + SEP + END + LRC, also 16 Zeichen insgesamt.

Beispiel der Erstellung einer auf 6 Zeichen begrenzten Datenreihe; Übermittlung des Codes "452"

SIGNIFICATO	BIT	PARITÀ
Start	1 0 1 1	0
"4"	0 1 0 0	0
"5"	0 1 0 1	1
"2"	0 0 1 1	0
End	1 1 1 1	1
LRC	0 1 1 1	0

Am Ende der Datenreihe wird das Kontrollzeichen **LRC** gesandt, das so berechnet wird, dass die Parität in Längsrichtung (auf den Spalten) der entsprechenden Bits wie aus der Tabelle ersichtlich gleich ist.

Der erste ausgegebene Bit ist **B1** und der letzte ist der für die Parität.

Zeitdiagramme der ISO2-Signale

Die ISO2-Signale sind 3: **CLS** (Card Loading Signal), **RCP** (Read Clock Pulse) und **RDP** (Read Data Pulse). Die 3 Signale sind nach unten aktiv.

Zuerst senkt sich **CLS** und nach 5 ms werden 10 "Clock"-Impulse gesandt. Danach wird das Datenpaket abgesandt und am Ende erfolgt eine Wartezeit von 5 ms bevor die **CLS** angehoben wird.

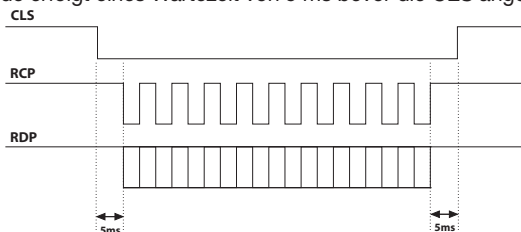

Die Periode hat eine Dauer von 1 ms und besteht aus folgenden Abschnitten:

400µs währenddessen die Linien **RDP** (Daten) und **RCP** (Clock) oben liegen.

300µs währenddessen die Linien **RDP** gesenkt ist, wenn das Bit den Wert 1 hat (**RCP** bleibt oben)

300µs (T_{ck}) währenddessen die Linien **RCP** gesenkt ist (**RDP** bleibt auf dem vorherigen Niveau).

Am Ende der Periode kehren **RCP** und **RDP** auf das hohe Niveau zurück.

$T_{ck} = 300\mu s$

$T_d = 600\mu s$

$T_p = 1ms$

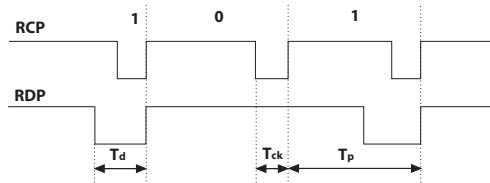

SERIELLE-PROTOKOL (BIT-SEQUENZ)

Das serielle Protokoll bietet am Ausgang der Anschlussklemme **DATA0** das Standard-Protokoll **RS232** (Baudrate = 9600, ohne Parität, 8 Bits, und ein Stop-Bit) im folgenden Format:

00C000B₁B₂B₃B₄B₅0

wobei 0 das ASCII-Zeichen "0" (30h) darstellt, **B₁B₂B₃B₄B₅0** sind die 5 Ziffern des Codes von geringerer Bedeutung im Hexadezimalsystem und "C" stellt den gemäß der angeführten Tabelle übersandten Kanal dar:

KANAL	ZEICHEN
A	1 (31h)
B	1 (32h)
C	1 (34h)
D	1 (38h)

Der Ausgang **DATA1** wird 200ms vor der Absendung der Daten an den Ausgang **DATA0** in der folgenden Weise aktiviert:

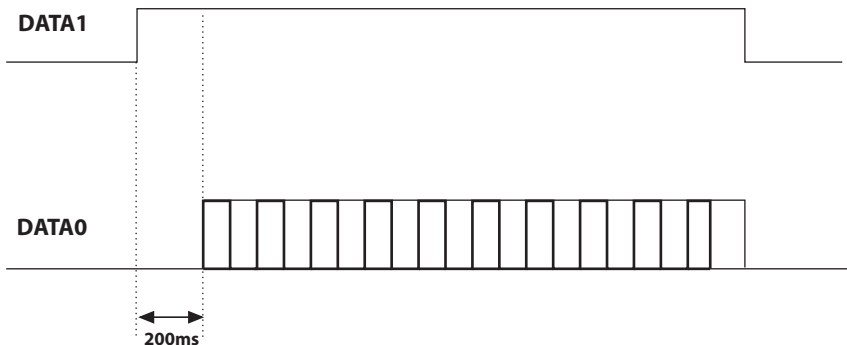

CODE-ABTRENNUNG

Bei der Wahl des Protokolls **WIEGAND** 1,2, 3, 6,7 und 9 (Seite 48...50) kann der Code des Senders S486 größer sein als der größte mit den zur Verfügung stehenden Bits darstellbare Code.

Bei herausgenommenen Jumper "**J1**" wird jeder **WIEGAND**-Ausgang deaktiviert, während am **RS232**-Ausgang die Information über den erhaltenen Code zur Verfügung steht.

Durch Einsetzung des Jumpers "**J1**" wird die Funktion "Code-Abtrennung" aktiviert. Diese Funktion eliminiert die wichtigeren Bit, die nicht im gewählten Format darstellbar sind.

Beispiel 1:

Wenn das Protokoll **WIEGAND** 26 Bit mit örtlichen Codes (Höchstanzahl **65'535**) gewählt wird und der Code des Senders **356'890** ist, wird die Funktion der Code-Abtrennung den ersten Bit löschen und der Code, der an den **WIEGAND**-Ausgang geleitet wird, wird somit **56'980** sein (Kleinere Zahl als **65'535**).

Beispiel 2:

Wenn das Protokoll **WIEGAND** 37 Bit mit örtlichen Codes (Höchstanzahl **542'287**) gewählt wird und der Code des Senders **18'436'500**, ist, wird die Abtrennungsfunktion den Code **436,500** liefern.



Achtung! Durch die Aktivierung der "Code-Abtrennungsfunktion" (Jumper "**J1**" geschlossen) besteht die Möglichkeit, dass zwei Sender mit unterschiedlichem Code am Ausgang der Schnittstelle eine identische Bit-Sequenz aktivieren. So aktivieren zum Beispiel im Falle des Formates **WIEGAND** 26 Bit mit dem Aufstellercode die Codes **138'612** und **238'612** am Ausgang die gleiche Bit-Sequenz, **38'612**.



CARDIN ELETTRONICA spa

Via Raffaello, 36- 31020 San Vendemiano (TV) Italy

Tel:

+39/0438.404011-401818

Fax:

+39/0438.401831

email (Italy):

Sales.office.it@cardin.it

email (Europe):

Sales.office@cardin.it

Http:

www.cardin.it

